

TOSHIBA

**DICOM CONFORMANCE STATEMENT
FOR
TOSHIBA DIGITAL RADIOGRAPHY SYSTEM**

MODEL HDR-08A

TOSHIBA MEDICAL SYSTEMS CORPORATION

© TOSHIBA MEDICAL SYSTEMS CORPORATION 2008-2016
ALL RIGHTS RESERVED

Trademarks

This document may include trademarks or registered trademarks of other companies.

IMPORTANT!

- (1) No part of this document may be copied or reprinted, in whole or in part, without written permission.
- (2) The contents of this document are subject to change without prior notice and without our legal obligation.
- (3) Please refer to the Toshiba Medical Systems Corporation website for the most recent version of this conformance statement.

English:"<http://www.toshibamedicalsystems.com/tmd/english/dicom/index.html>"
Japanese:"<http://www.toshiba-medical.co.jp/tmd/products/dicom/index.html>"

1. CONFORMANCE STATEMENT OVERVIEW

Table 1-1 provides an overview of the network services supported by HDR-08A.

**Table 1-1
NETWORK SERVICES**

SOP Classes	User of Service (SCU)	Provider of Service (SCP)
Transfer		
X-Ray Radiofluoroscopic Image Storage	Yes	No
X-Ray Angiographic Image Storage	Yes	No
Secondary Capture Image Storage	Yes	No
X-Ray Radiation Dose SR	Yes	No
Storage Commitment		
Storage Commitment Push Model	Yes ^{*1}	No
Workflow Management		
Modality Worklist Information Model – Find	Yes ^{*2}	No
Modality Performed Procedure Step	Yes ^{*3}	No
Print Management		
Basic Grayscale Print Management	Yes	No

*1: HDRK-COMMIT option must be installed.

*2: HDRK-MWM or HDRK-MPPS option must be installed.

*3: HDRK-MPPS option must be installed

Table 1-2 provides an overview of the Media Storage Application Profiles supported by HDR-08A.

**Table 1-2
MEDIA SERVICES**

Media Storage Application Profile	Write Files (FSC)	Read Files (FSR)
Compact Disk - Recordable		
General Purpose CD-R	Yes ^{*1}	No
DVD		
General Purpose DVD-R	Yes ^{*1}	No

*1: HDRK-DCMDIR option must be installed.

2. TABLE OF CONTENTS

1.	CONFORMANCE STATEMENT OVERVIEW	i
2.	TABLE OF CONTENTS	a
3.	INTRODUCTION	1
3.1	AUDIENCE.....	1
3.2	REMARKS	1
3.3	DEFINITIONS, TERMS AND ABBREVIATIONS	2
3.4	REFERENCES.....	2
4.	NETWORKING.....	3
4.1	IMPLEMENTATION MODEL.....	3
4.1.1	Application Data Flow	3
4.1.2	Functional Definition of AEs	5
4.1.3	Sequencing of Real-World Activities.....	6
4.2	AE SPECIFICATIONS	8
4.2.1	Storage SCU AE Specification	8
4.2.2	Storage Commitment SCU AE Specification	13
4.2.3	MWM SCU AE Specification.....	20
4.2.4	MPPS SCU AE Specification	25
4.2.5	Print SCU AE Specification	31
4.2.6	Verification SCU AE Specification.....	43
4.3	NETWORK INTERFACES.....	46
4.3.1	Physical Network Interface.....	46
4.3.2	Additional Protocols	46
4.4	CONFIGURATION	47
4.4.1	AE Title/Presentation Address Mapping	47
4.4.2	Parameters	48
5.	MEDIA INTERCHANGE	50
5.1	IMPLEMENTATION MODEL.....	50
5.1.1	Application Data Flow	50
5.1.2	Functional Definition of AE.....	50
5.1.3	Sequencing of Real-World Activities.....	51
5.1.4	File Meta Information for Implementation Class and Version	51
5.2	AE SPECIFICATIONS	51
5.2.1	Offline-Media AE Specification.....	51
5.3	AUGMENTED AND PRIVATE APPLICATION PROFILES.....	53
5.3.1	Augmented Application Profiles	53
5.3.2	Private Application Profiles	53
5.4	MEDIA CONFIGURATION	53
6.	SUPPORT OF CHARACTER SETS.....	54
7.	SECURITY.....	55
8.	ANNEXES	56
8.1	IOD CONTENTS	56
8.1.1	Created SOP Instances	56
8.1.2	Usage of Attributes from received IOD's.....	88

8.1.3	Attribute Mapping	88
8.1.4	Corrected/Modified Fields	89
8.2	DATA DICTIONARY OF PRIVATE ATTRIBUTES.....	89
8.3	CONTROLLED TERMINOLOGY AND TEMPLATES.....	89
8.4	GRAYSCALE IMAGE CONSISTENCY	89
8.5	STANDARD EXTENDED/SPECIALIZED/PRIVATE SOP CLASSES	89
8.5.1	Modality Worklist Information Model – Find	89
8.5.2	Modality Performed Procedure Step	89
8.6	PRIVATE TRANSFER SYNTAXES.....	89

3. INTRODUCTION

3.1 AUDIENCE

This document is intended for hospital staff, health system integrators, software designers or implementers. It is assumed that the reader has a working understanding of DICOM.

3.2 REMARKS

DICOM, by itself, does not guarantee interoperability. However, the Conformance Statement facilitates a first-level validation for interoperability between different applications supporting the same DICOM functionality.

This Conformance Statement is not intended to replace validation with other DICOM equipment to ensure proper exchange of information intended.

The scope of this Conformance Statement is to facilitate communication with Toshiba Medical Systems and other vendors' Medical equipment. The Conformance Statement should be read and understood in conjunction with the DICOM Standard [DICOM]. However, by itself it is not guaranteed to ensure the desired interoperability and a successful interconnectivity.

The user should be aware of the following important issues:

- The comparison of different conformance statements is the first step towards assessing interconnectivity between Toshiba Medical Systems and non- Toshiba Medical Systems equipment.
- Test procedures should be defined to validate the desired level of connectivity.
- The DICOM standard will evolve to meet the users' future requirements. Toshiba Medical Systems is actively involved in developing the standard further and therefore reserves the right to make changes to its products or to discontinue its delivery.

3.3 DEFINITIONS, TERMS AND ABBREVIATIONS

Definitions, terms and abbreviations used in this document are defined within the different parts of the DICOM standard.

Abbreviations and terms are as follows:

AE	Application Entity
ASCE	Association Control Service Element
CD-R	Compact Disk Recordable
DIMSE	DICOM Message Service Element
DVD	A trademark of the DVD forum that is not an abbreviation
DVD-R	DVD Recordable
FSC	File-Set Creator
FSU	File-Set Updater
FSR	File-Set Reader
IE	Information Entity
IOD	Information Object Definition
ISO	International Standard Organization
MPPS	Modality Performed Procedure Step
MSPS	Modality Scheduled Procedure Step
MWM	Modality Worklist Management
R	Required Key Attribute
O	Optional Key Attribute
PDU	Protocol Data Unit
SCU	Service Class User (DICOM client)
SCP	Service Class Provider (DICOM server)
SOP	Service-Object Pair
U	Unique Key Attribute
UID	Unique Identifier

3.4 REFERENCES

[DICOM] Digital Imaging and Communications in Medicine (DICOM), NEMA PS 3.1-3.18.

4. NETWORKING

4.1 IMPLEMENTATION MODEL

4.1.1 Application Data Flow

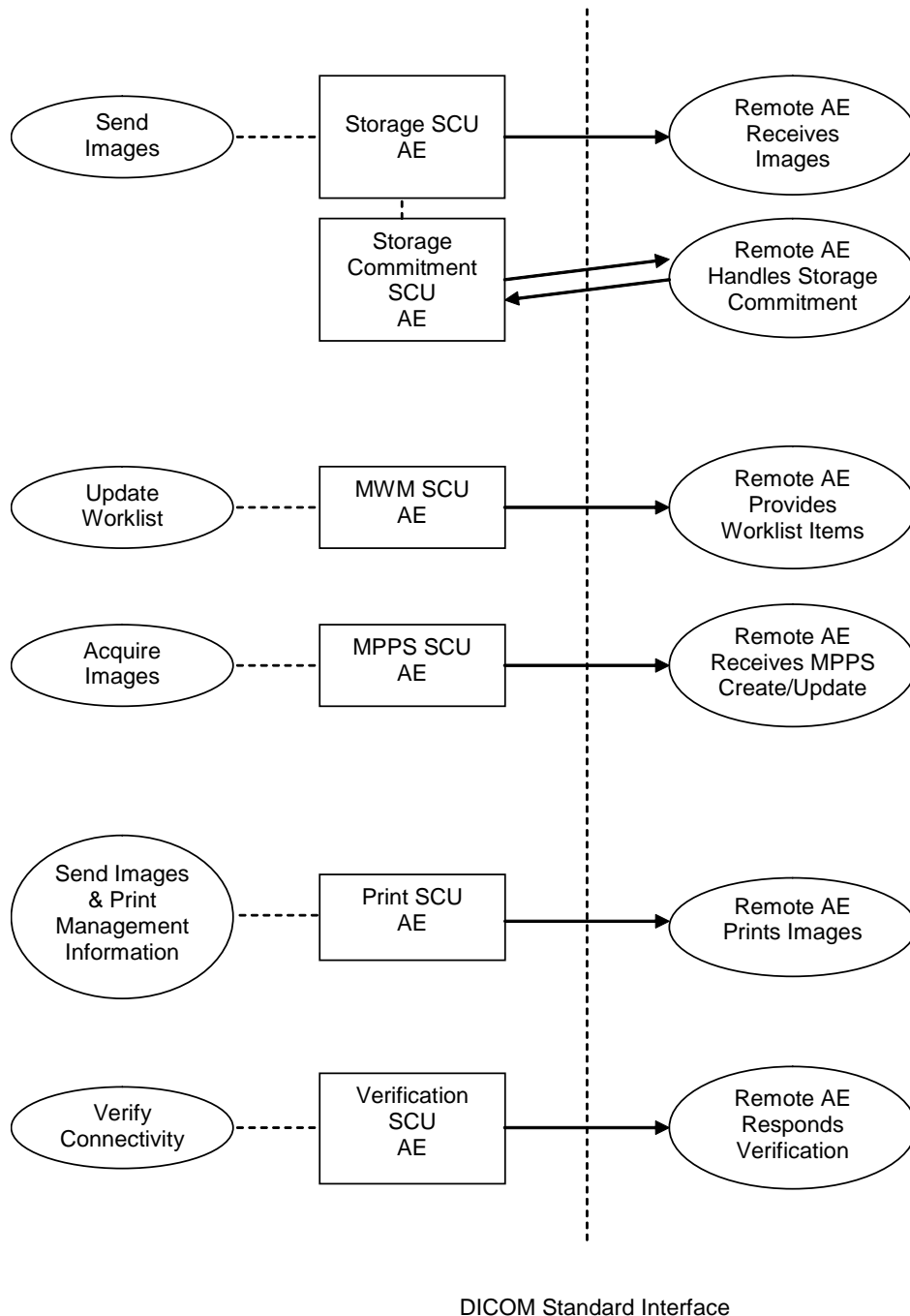

**Figure 4.1-1
APPLICATION DATA FLOW DIAGRAM**

- The Storage SCU AE sends images to a remote AE manually or automatically. It is associated with the local real-world activity “Send Images”. “Send Images” is performed upon user request for specific images selected or upon acquiring a new image.
If the remote AE is configured as a Storage Commitment SCP AE, the Storage SCU AE will send a storage commitment requests to the Storage Commitment SCU AE.
- Receiving the storage commitment request from the Storage SCU AE, the Storage Commitment SCU AE will request Storage Commitment and if a commitment is successfully obtained the Storage Commitment SCU AE will record this information in the local database.
- The MWM SCU AE receives Worklist information from a remote AE. It is associated with the local real-world activity “Update Worklist”. When the “Update Worklist” is performed the MWM SCU AE queries a remote AE for worklist items and provides the set of worklist items matching the query request. “Update Worklist” is performed manually or automatically.
- The MPPS SCU AE sends MPPS information to a remote AE. It is associated with the local real-world activity “Acquire Images”. When the “Acquire Images” is performed, the MPPS SCU AE creates and updates Modality Performed Procedure Step instances managed by a remote AE. Acquisition of images will result in automated creation of an MPPS Instance. Completion of the MPPS is performed as the result of an operator action.
- The Print SCU AE prints images on a remote AE (Printer). It is associated with the local real-world activity “Send Images & Print Management Information”. “Send Images & Print Management Information” creates a print-job within the print queue containing one or more virtual film sheets composed from images selected by the user or from images acquired automatically.
- The Verification SCU AE issues a C-ECHO to verify a DICOM connection to a remote AE. It is associated with the local real-world activity “Verify Connectivity”. “Verify Connectivity” is performed by the service man.

4.1.2 Functional Definition of AEs

4.1.2.1 Functional Definition of Storage SCU AE

The existence of a send-job queue entry with associated network destination will activate the Storage SCU AE. An association request is sent to the destination AE and upon successful negotiation of a Presentation Context the image transfer is started.

If the image transfer fails, the Storage SCU AE will retry this send-job automatically.

If the remote AE is configured as a Storage Commitment SCP AE, the storage SCU AE will send a storage commitment request to the Storage Commitment SCU AE.

4.1.2.2 Functional Definition of Storage Commitment SCU AE

Receiving the storage commitment request from the Storage SCU AE, the Storage Commitment SCU AE will request Storage Commitment and if a commitment is successfully obtained the Storage Commitment SCU AE will record this information in the local database.

4.1.2.3 Functional Definition of MWM SCU AE

The MWM SCU AE attempts to download a worklist from a remote node. If the MWM SCU AE establishes an association to a remote AE, it will transfer patient's information and worklist items via the open Association. The results will be displayed in a separate list. The patient's information will be used for the patient registration.

4.1.2.4 Functional Definition of MPPS SCU AE

The MPPS SCU AE performs the creation of an MPPS Instance automatically when the user selects and starts a worklist item. Further updates on the MPPS data can be performed when the user completes the study.

4.1.2.5 Functional Definition of Print SCU AE

The existence of a print-job in the print queue will activate the Print SCU AE. An association is established with the printer and the printer's status determined. If the printer is operating normally, the film sheets described within the print-job will be printed.

If the printer is not operating normally, an error message will be displayed and this print-job can be canceled or restarted by the user operations.

4.1.2.6 Functional Definition of Verification SCU AE

The Verification SCU AE issues a C-ECHO to verify a DICOM connection to a remote AE. It is performed by the user upon a DICOM connection error.

4.1.3 Sequencing of Real-World Activities

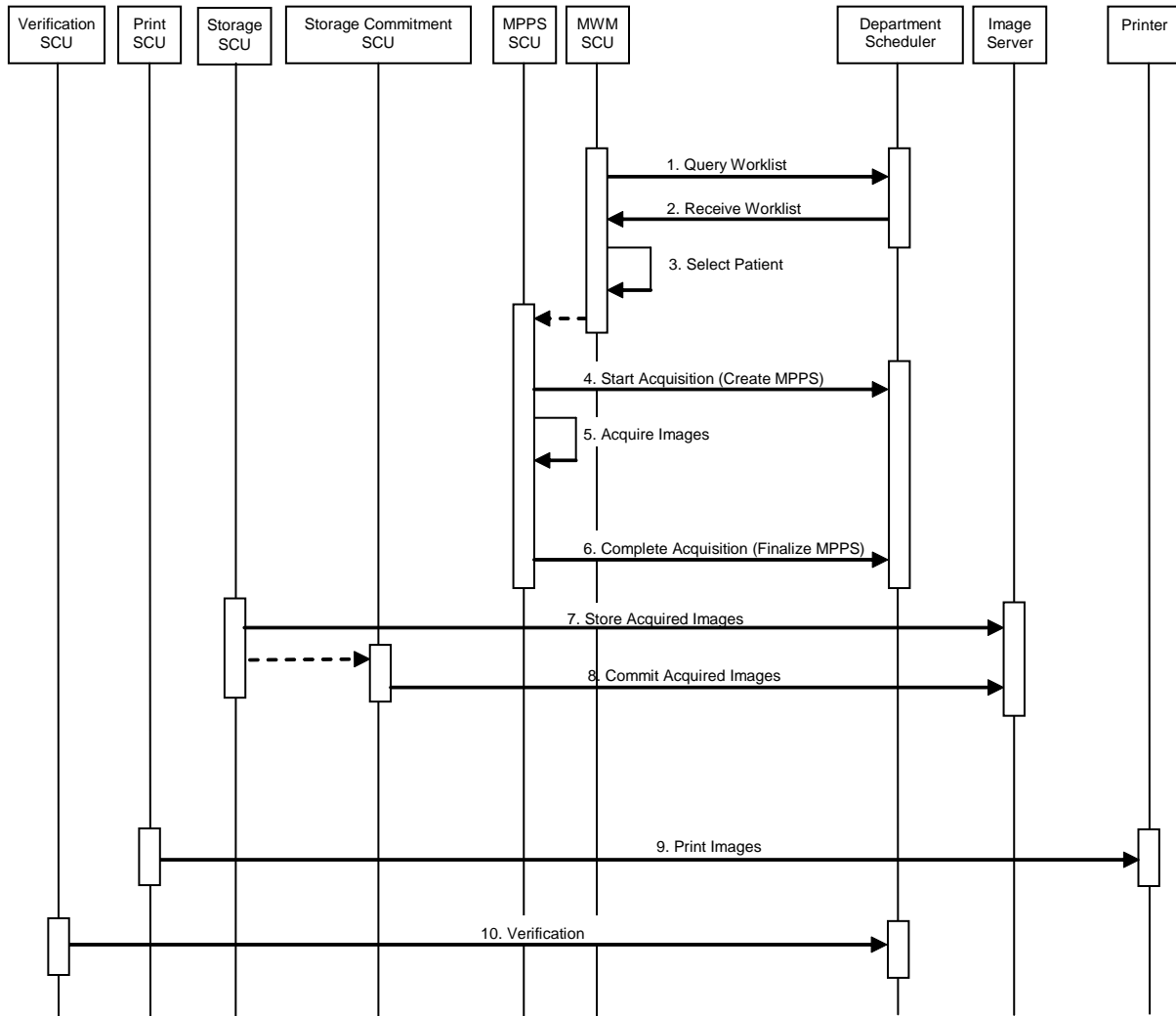

Figure 4.1-2
SEQUENCING CONSTRAINTS

Under typical scheduled workflow conditions the sequencing constraints illustrated in Figure 4.1-2 apply:

1. Query Worklist
2. Receive Worklist of Modality Scheduled Procedure Steps (MSPS)
3. Select Patient from Worklist
4. Start Acquisition and Create MPPS
5. Acquire Images
6. Complete Acquisition and Finalize MPPS
7. Store Acquired Images
8. Commit Acquired Images
9. Print Images
10. Verification

Other workflow situations (e.g. unscheduled procedure steps) will have other sequencing constraints. Some activities may be omitted according to situations.

4.2 AE SPECIFICATIONS

4.2.1 Storage SCU AE Specification

4.2.1.1 SOP Classes

The Storage SCU AE provides Standard Conformance to the following SOP Classes:

Table 4.2-1
SOP CLASSES FOR THE STORAGE SCU AE

SOP Class Name	SOP Class UID	SCU	SCP
X-Ray Radiofluoroscopic Image Storage	1.2.840.10008.5.1.4.1.1.12.2	Yes	No
X-Ray Angiographic Image Storage	1.2.840.10008.5.1.4.1.1.12.1	Yes	No
Secondary Capture Image Storage (Grayscale)	1.2.840.10008.5.1.4.1.1.7	Yes	No
X-Ray Radiation Dose SR	1.2.840.10008.5.1.4.1.1.88.67	Yes	No

4.2.1.2 Association Policies

4.2.1.2.1 General

The DICOM standard application context name for DICOM 3.0 is always proposed:

Table 4.2-2
DICOM APPLICATION CONTEXT FOR THE STORAGE SCU AE

Application Context Name	1.2.840.10008.3.1.1.1
--------------------------	-----------------------

4.2.1.2.2 Number of Association

The Storage SCU AE can initiate one association at a time for each destination to which a transfer request is being processed in the active job queue list. Only one job will be active at a time, the other remains pending until the active job is completed or failed.

Table 4.2-3
NUMBER OF ASSOCIATIONS INITIATED FOR THE STORAGE SCU AE

Maximum number of simultaneous associations	1
---	---

4.2.1.2.3 Asynchronous Nature

The Storage SCU AE does not support asynchronous communication (multiple outstanding transactions over a single association).

Table 4.2-4
ASYNCHRONOUS NATURE FOR THE STORAGE SCU AE

Maximum number of outstanding asynchronous transactions	1
---	---

4.2.1.2.4 Implementation Identifying Information

The implementation information for the Storage SCU AE is:

Table 4.2-5
DICOM IMPLEMENTATION CLASS AND VERSION FOR THE STORAGE SCU AE

Implementation Class UID	2.16.840.1.113669.632.3.1.1.2.7
Implementation Version Name	Harmony

4.2.1.3 Association Initiation Policy

4.2.1.3.1 Activity – Send Images

4.2.1.3.1.1 Description and Sequencing of Activities

The Storage SCU AE attempts to initiate a new association in order to issue a Storage request (C-STORE). If the job contains multiple images then multiple C-STORE requests will be issued over the same association. If the image transfer fails, the Storage SCU AE will retry this send-job automatically.

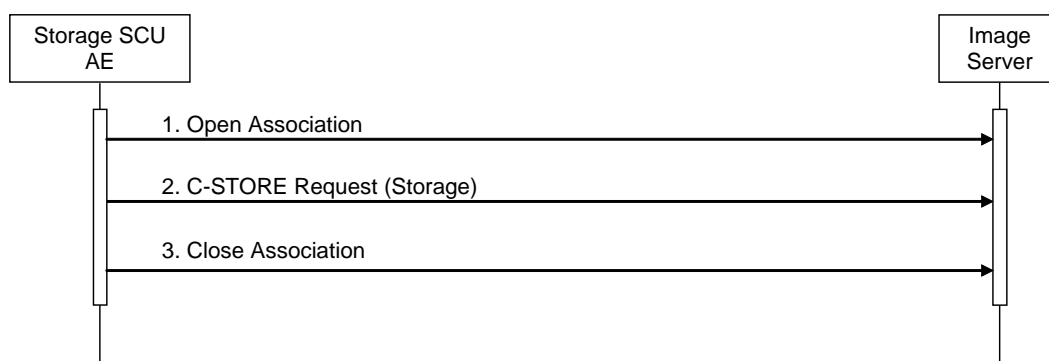

Figure 4.2-1
SEQUENCING OF ACTIVITY – SEND IMAGES

A possible sequence of interactions between the Storage SCU AE and an Image Server is illustrated in the Figure above:

1. The Storage SCU AE opens an association with the Image Server
2. Acquired images are transmitted to the Image Server using a Storage request (C-STORE) and the Image Server replies with a C-STORE response (status success).
3. The Storage SCU AE closes the association with the Image Server.

4.2.1.3.1.2 Proposed Presentation Contexts

The Storage SCU AE is capable of proposing the Presentation Contexts shown in the following table:

**Table 4.2-6
PROPOSED PRESENTATION CONTEXTS FOR ACTIVITY SEND IMAGES**

Presentation Context Table					
Abstract Syntax		Transfer Syntax		Role	Ext. Neg.
Name	UID	Name List	UID List		
X-Ray Radiofluoroscopic Image Storage	1.2.840.10008.5.1.4 .1.1.12.2	Implicit VR Little Endian Explicit VR Little Endian	1.2.840.10008.1.2 1.2.840.10008.1.2.1	SCU	None
X-Ray Angiographic Image Storage	1.2.840.10008.5.1.4 .1.1.12.1	Implicit VR Little Endian Explicit VR Little Endian	1.2.840.10008.1.2 1.2.840.10008.1.2.1	SCU	None
Secondary Capture Image Storage (Grayscale)	1.2.840.10008.5.1.4 .1.1.7	Implicit VR Little Endian Explicit VR Little Endian	1.2.840.10008.1.2 1.2.840.10008.1.2.1	SCU	None
X-Ray Radiation Dose SR	1.2.840.10008.5.1.4 .1.1.88.67	Explicit VR Little Endian	1.2.840.10008.1.2.1	SCU	None

4.2.1.3.1.3 SOP Specific Conformance for Storage SOP Classes

The Storage SCU AE provides standard conformance to the Storage Service Class as an SCU.

The behavior of Storage SCU AE when encountering status codes in a C-STORE response is summarized in the table below:

Table 4.2-7
STORAGE C-STORE RESPONSE STATUS HANDLING BEHAVIOR

Service Status	Further Meaning	Status Code	Behavior
Success	Success	0000	The SCP has successfully stored the SOP Instance. If all SOP Instances in a send job have status success then the job is marked as complete.
Refused	Out of Resources	A7xx	The association is aborted using A-ABORT and the send job is marked as failed. The status meaning is logged and the job failure is reported to the user via the job control application. This is a transient failure.
Error	Data Set does not match SOP Class	A9xx	The association is aborted using A-ABORT and the send job is marked as failed. The status meaning is logged and the job failure is reported to the user via the job control application.
Error	Cannot Understand	Cxxx	The association is aborted using A-ABORT and the send job is marked as failed. The status meaning is logged and the job failure is reported to the user via the job control application.
Warning	Coercion of Data Elements	B000	Image transmission is considered successful if it is configured that the status would be considered successful.
Warning	Data Set does not match SOP Class	B007	Image transmission is considered successful if it is configured that the status would be considered successful.
Warning	Elements Discarded	B006	Image transmission is considered successful if it is configured that the status would be considered successful.
*	*	Any other status code.	The association is aborted using A-ABORT and the send job is marked as failed. The status code is logged and the job failure is reported to the user via the job control application.

The behavior of Storage SCU AE during communication failure is summarized in the table below:

Table 4.2-8
STORAGE COMMUNICATION FAILURE BEHAVIOR

Exception	Behavior
Timeout	The association is aborted and the send job is marked as failed. The reason is logged and the job failure is reported to the user via the job control application.
Association aborted by the SCP or network layers	The send job is marked as failed. The reason is logged and the job failure is reported to the user via the job control application.

If the image transfer fails, the Storage SCU AE will retry this send-job automatically. The number of retries is configurable.

The contents of Image Storage SOP Instances created by the Storage SCU AE conform to the DICOM Image IOD definitions and are described in section 8.1.

4.2.1.4 Association Acceptance Policy

The Storage SCU AE does not accept associations.

4.2.2 Storage Commitment SCU AE Specification

4.2.2.1 SOP Classes

The Storage Commitment SCU AE provides Standard Conformance to the following SOP Classes:

Table 4.2-9
SOP Classes for THE Storage commitment SCU AE

SOP Class Name	SOP Class UID	SCU	SCP
Storage Commitment Push Model	1.2.840.10008.1.20.1	Yes	No

4.2.2.2 Association Policies

4.2.2.2.1 General

The DICOM standard application context name for DICOM 3.0 is always proposed:

Table 4.2-10
DICOM APPLICATION CONTEXT FOR THE STORAGE COMMITMENT SCU AE

Application Context Name	1.2.840.10008.3.1.1.1
--------------------------	-----------------------

4.2.2.2.2 Number of Associations

The Storage Commitment SCU AE initiates one Association at a time.

Table 4.2-11
NUMBER OF ASSOCIATIONS INITIATED FOR THE STORAGE COMMITMENT SCU AE

Maximum number of simultaneous Associations	1
---	---

The Storage Commitment SCU AE accepts Associations to receive N-EVENT-REPORT notifications for the Storage Commitment Push Model SOP Class.

Table 4.2-12
NUMBER OF ASSOCIATIONS ACCEPTED FOR THE STORAGE COMMITMENT SCU AE

Maximum number of simultaneous Associations	1
---	---

4.2.2.2.3 Asynchronous Nature

The Storage Commitment SCU AE does not support asynchronous communication (multiple outstanding transactions over a single Association).

Table 4.2-13
ASYNCHRONOUS NATURE FOR THE STORAGE COMMITMENT SCU AE

Maximum number of outstanding asynchronous transactions	1
---	---

4.2.2.2.4 Implementation Identifying Information

The implementation information for the Storage Commitment SCU AE is:

Table 4.2-14
DICOM IMPLEMENTATION CLASS AND VERSION FOR THE STORAGE COMMITMENT SCU AE

Implementation Class UID	2.16.840.1.113669.632.3.1.1.2.7
Implementation Version Name	Harmony

4.2.2.3 Association Initiation Policy

4.2.2.3.1 Activity – Commit Sent Images

4.2.2.3.1.1 Description and Sequencing of Activities

If the remote AE is configured as an archive device the Storage Commitment SCU AE will, after all images have been sent, transmit a single Storage Commitment request (N-ACTION). Upon receiving the N-ACTION response the Storage Commitment SCU AE will release the Association. The notification of Storage commitment (N-EVENT-REPORT) will be received over a separate Association.

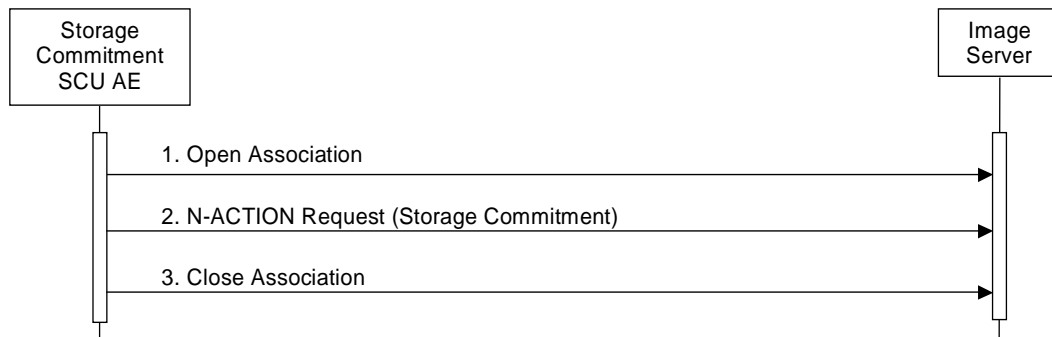

Figure 4.2-2
SEQUENCING OF ACTIVITY – COMMIT SENT IMAGES

A possible sequence of interactions between the Storage Commitment SCU AE and an Image Server (e.g. a storage or archive device supporting the Storage Commitment SOP Classes as an SCP) is illustrated in the Figure above:

1. The Storage Commitment SCU AE opens an Association with the Image Server.
2. A Storage Commitment request (N-ACTION) is transmitted to the Image Server to obtain Storage Commitment of previously transmitted images. The Image Server replies with an N-ACTION response indicating the request has been received and is being processed.
3. The Storage Commitment AE closes the Association with the Image Server.

NOTE: The N-EVENT-REPORT will be sent over a separate Association initiated by the Image Server (see Section 4.2.2.4.1).

4.2.2.3.1.2 Proposed Presentation Contexts

The Storage Commitment SCU AE is capable of proposing the Presentation Contexts shown in the following table:

Table 4.2-15
PROPOSED PRESENTATION CONTEXTS FOR ACTIVITY COMMIT SENT IMAGES

Presentation Context Table					
Abstract Syntax		Transfer Syntax		Role	Ext. Neg.
Name	UID	Name List	UID List		
Storage Commitment Push Model	1.2.840.10008.1.20.1	Implicit VR Little Endian Explicit VR Little Endian	1.2.840.10008.1.2 1.2.840.10008.1.2.1	SCU	None

A Presentation Context for the Storage Commitment Push Model will only be proposed if the remote AE is configured as an archive device.

4.2.2.3.1.3 SOP Specific Conformance for Storage Commitment SOP Class

4.2.2.3.1.3.1 Storage Commitment Operations (N-ACTION)

The Storage Commitment SCU AE provides standard conformance to the Storage Commitment Service Class as an SCU.

The Storage Commitment SCU AE will request storage commitment for instances of the Storage SOP Classes if the remote AE is configured as an archive device and a presentation context for the Storage Commitment Push Model has been accepted.

The behavior of Storage SCU Commitment AE when encountering status codes in an N-ACTION response is summarized in the table below:

**Table 4.2-16
STORAGE COMMITMENT N-ACTION RESPONSE STATUS HANDLING BEHAVIOR**

Service Status	Further Meaning	Status Code	Behavior
Success	Success	0000	The request for storage commitment is considered successfully sent. A timer is started which will expire if no N-EVENT-REPORT for the Transaction UID is received within a configurable timeout period.
*	*	Any other status code.	The Association is aborted using A-ABORT and the request for storage commitment is marked as failed.

The behavior of Storage Commitment AE during communication failure is summarized in the table below:

**Table 4.2-17
STORAGE COMMITMENT COMMUNICATION FAILURE BEHAVIOR**

Exception	Behavior
Timeout	The Association is aborted using A-ABORT and the send job is marked as failed. The reason is logged and the job failure is reported to the user via the job control application.
Association aborted by the SCP or network layers	The send job is marked as failed. The reason is logged and the job failure is reported to the user via the job control application.

4.2.2.4 Association Acceptance Policy

4.2.2.4.1 Activity – Receive Storage Commitment Response

4.2.2.4.1.1 Description and Sequencing of Activities

The Storage Commitment SCU AE will accept Associations in order to receive responses to a Storage Commitment Request.

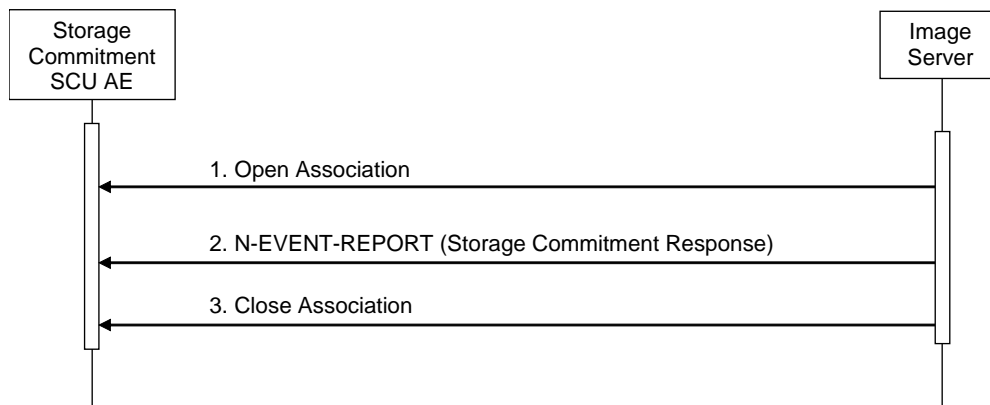

Figure 4.2-3
SEQUENCING OF ACTIVITY - RECEIVE STORAGE COMMITMENT RESPONSE

A possible sequence of interactions between the Storage Commitment SCU AE and an Image Server (e.g. a storage or archive device supporting Storage Commitment SOP Classes as an SCP) is illustrated in the Figure above:

1. The Image Server opens a new Association with the Storage Commitment SCU AE.
2. The Image Server sends an N-EVENT-REPORT request notifying the Storage Commitment SCU AE of the status of a previous Storage Commitment Request. The Storage Commitment SCU AE replies with an N-EVENT-REPORT response confirming receipt.
3. The Image Server closes the Association with the Storage Commitment SCU AE.

The Storage Commitment SCU AE may reject Association attempts as shown in the table below. The Result, Source and Reason/Diag columns represent the values returned in the appropriate fields of an ASSOCIATE-RJ PDU (see PS 3.8, Section 9.3.4). The contents of the Source column is abbreviated to save space and the meaning of the abbreviations are:

- a) 1 – DICOM UL service-user
- b) 2 – DICOM UL service-provider (ASCE related function)
- c) 3 – DICOM UL service-provider (Presentation related function)

**Table 4.2-18
ASSOCIATION REJECTION REASONS**

Result	Source	Reason/Diag	Explanation
2 – rejected-transient	c	2 – local-limit-exceeded	The (configurable) maximum number of simultaneous Associations has been reached. An Association request with the same parameters may succeed at a later time.
2 – rejected-transient	c	1 – temporary-congestion	No Associations can be accepted at this time due to the real-time requirements of higher priority activities (e.g. during image acquisition no Associations will be accepted) or because insufficient resources are available (e.g. memory, processes, threads). An Association request with the same parameters may succeed at a later time.
1 – rejected-permanent	a	2 – application-context-na me-not-supported	The Association request contained an unsupported Application Context Name. An Association request with the same parameters will not succeed at a later time.
1 – rejected-permanent	a	7 – called-AE-title-not-reco gnized	The Association request contained an unrecognized Called AE Title. An Association request with the same parameters will not succeed at a later time unless configuration changes are made. This rejection reason normally occurs when the Association initiator is incorrectly configured and attempts to address the Association acceptor using the wrong AE Title.
1 – rejected-permanent	a	3 – calling-AE-title-not-rec ognized	The Association request contained an unrecognized Calling AE Title. An Association request with the same parameters will not succeed at a later time unless configuration changes are made. This rejection reason normally occurs when the Association acceptor has not been configured to recognize the AE Title of the Association initiator.
1 – rejected-permanent	b	1 – no-reason-given	The Association request could not be parsed. An Association request with the same format will not succeed at a later time.

4.2.2.4.1.2 Accepted Presentation Contexts

The Storage Commitment SCU AE will accept Presentation Contexts as shown in the table below.

**Table 4.2-19
ACCEPTABLE PRESENTATION CONTEXTS FOR
ACTIVITY RECEIVE STORAGE COMMITMENT RESPONSE**

Presentation Context Table					
Abstract Syntax		Transfer Syntax		Role	Ext. Neg.
Name	UID	Name List	UID List		
Verification	1.2.840.10008.1.1	Implicit VR Little Endian Explicit VR Little Endian	1.2.840.10008.1.2 1.2.840.10008.1.2.1	SCP	None
Storage Commitment Push Model	1.2.840.10008.1.2 0.1	Implicit VR Little Endian Explicit VR Little Endian	1.2.840.10008.1.2 1.2.840.10008.1.2.1	SCU	None

4.2.2.4.1.3 SOP Specific Conformance for Storage Commitment SOP Class

4.2.2.4.1.3.1 Storage Commitment Notifications (N-EVENT-REPORT)

The Storage Commitment SCU AE provides standard conformance to the Storage Commitment Service Class as an SCU.

The behavior of Storage Commitment SCU AE when receiving Event Types within the N-EVENT-REPORT is summarized in the table below.

**Table 4.2-20
STORAGE COMMITMENT N-EVENT-REPORT BEHAVIOUR**

Event Type Name	Event Type ID	Behavior
Storage Commitment Request Successful	1	The Storage Commitment SCU AE permits the operator(s) to delete the Referenced SOP Instances under Referenced SOP Sequence (0008,1199), or deletes the Instances from the local database automatically.
Storage Commitment Request Complete – Failures Exist	2	The Storage Commitment SCU AE requests the Storage SCU AE to send the Referenced SOP Instances under Failed SOP Sequence (0008,1198).

The reasons for returning specific status codes in an N-EVENT-REPORT response are summarized in the table below.

**Table 4.2-21
STORAGE COMMITMENT N-EVENT-REPORT RESPONSE STATUS REASONS**

Service Status	Further Meaning	Status Code	Reasons
Success	Success	0000	The storage commitment result has been successfully received.
Failure	Unrecognized Operation	0211H	The Transaction UID in the N-EVENT-REPORT request is not recognized (was never issued within an N-ACTION request).
Failure	Resource Limitation	0213H	The Transaction UID in the N-EVENT-REPORT request has expired (no N-EVENT-REPORT was received within a configurable time limit).
Failure	No Such Event Type	0113H	An invalid Event Type ID was supplied in the N-EVENT-REPORT request.
Failure	Processing Failure	0110H	An internal error occurred during processing of the N-EVENT-REPORT. A short description of the error will be returned in Error Comment (0000,0902).
Failure	Invalid Argument Value	0115H	One or more SOP Instance UIDs with the Referenced SOP Sequence (0008,1199) or Failed SOP Sequence (0008,1198) was not included in the Storage Commitment Request associated with this Transaction UID. The unrecognized SOP Instance UIDs will be returned within the Event Information of the N-EVENT-REPORT response.

4.2.2.4.1.4 SOP Specific Conformance for Verification SOP Class

The Storage Commitment SCU AE provides standard conformance to the Verification SOP Class as an SCP.

4.2.3 MWM SCU AE Specification

4.2.3.1 SOP Classes

The MWM SCU AE provides Standard Conformance to the following SOP Classes:

Table 4.2-22
SOP CLASSES FOR THE MWM SCU AE

SOP Class Name	SOP Class UID	SCU	SCP
Modality Worklist Information Model – FIND	1.2.840.10008.5.1.4.31	Yes	No

4.2.3.2 Association Policies

4.2.3.2.1 General

The DICOM standard application context name for DICOM 3.0 is always proposed:

Table 4.2-23
DICOM APPLICATION CONTEXT FOR THE MWM SCU AE

Application Context Name	1.2.840.10008.3.1.1.1
--------------------------	-----------------------

4.2.3.2.2 Number of Associations

The MWM SCU AE initiates one association at a time for a Worklist request.

Table 4.2-24
NUMBER OF ASSOCIATIONS INITIATED FOR THE MWM SCU AE

Maximum number of simultaneous associations	1
---	---

4.2.3.2.3 Asynchronous Nature

The MWM SCU AE does not support asynchronous communication (multiple outstanding transactions over a single association).

Table 4.2-25
ASYNCHRONOUS NATURE FOR THE MWM SCU AE

Maximum number of outstanding asynchronous transactions	1
---	---

4.2.3.2.4 Implementation Identifying Information

The implementation information for this Application Entity is:

Table 4.2-26
DICOM IMPLEMENTATION CLASS AND VERSION FOR THE MWM SCU AE

Implementation Class UID	2.16.840.1.113669.632.3.1.1.2.7
Implementation Version Name	Harmony

4.2.3.3 Association Initiation Policy

4.2.3.3.1 Activity – Update Worklist

4.2.3.3.1.1 Description and Sequencing of Activities

The request for An “Update Worklist” is initiated by user interaction or automatically at the time of patient registration.

Upon initiation of the request, the MWM SCU AE will build an identifier for the C-FIND request, will initiate an association to send the request and will wait for Worklist responses. After retrieval of all responses, the MWM SCU AE will access the local database to add or update patient demographic data. The results will be displayed in a separate list.

The MWM SCU AE will initiate an association in order to issue a C-FIND request according to the Modality Worklist Information Model.

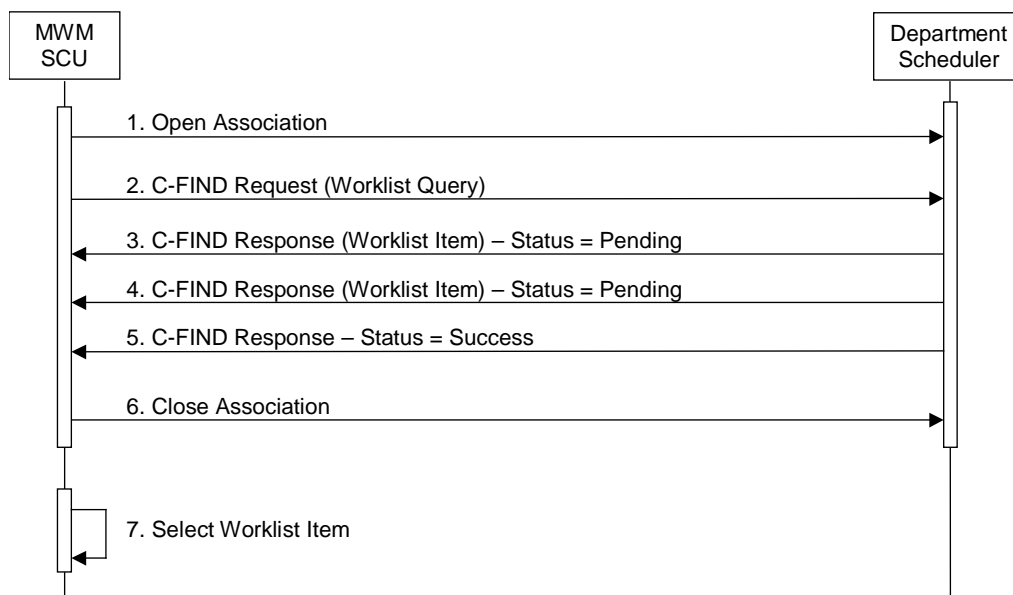

Figure 4.2-4
SEQUENCING OF ACTIVITY – UPDATE WORKLIST

A possible sequence of interactions between the MWM SCU AE and a Department Scheduler (e.g. a device such as a RIS or HIS which supports the Modality Worklist SOP Class as an SCP) is illustrated in the Figure above:

1. The MWM SCU AE opens an association with the Department Scheduler
2. The MWM SCU AE sends a C-FIND request to the Department Scheduler containing the Worklist Query attributes.
3. The Department Scheduler returns a C-FIND response containing the requested attributes of the first matching Worklist Item.
4. The Department Scheduler returns another C-FIND response containing the requested attributes of the second matching Worklist Item.
5. The Department Scheduler returns another C-FIND response with status Success indicating that no further matching Worklist Items exist. This example assumes that only two Worklist items match the Worklist Query.
6. The MWM SCU AE closes the association with the Department Scheduler.
7. The user selects a worklist item from the Worklist and prepares to acquire new images.

4.2.3.3.1.2 Proposed Presentation Contexts

The MWM SCU AE will propose Presentation Contexts as shown in the following table:

Table 4.2-27
Proposed Presentation Contexts for Activity Update Worklist

Presentation Context Table					
Abstract Syntax		Transfer Syntax		Role	Ext. Neg.
Name	UID	Name List	UID List		
Modality Worklist Information Model – FIND	1.2.840.10008.5.1.4.31	Implicit VR Little Endian Explicit VR Little Endian	1.2.840.10008.1.2 1.2.840.10008.1.2.1	SCU	None

4.2.3.3.1.3 SOP Specific Conformance for Modality Worklist SOP Class

The MWM SCU AE provides standard conformance to the Modality Worklist SOP Class as an SCU.

The behavior of the MWM SCU when encountering status codes in a Modality Worklist C-FIND response is summarized in the table below.

Table 4.2-28
Modality Worklist C-FIND Response Status Handling Behavior

Service Status	Further Meaning	Status Code	Behavior
Success	Matching is complete	0000	The SCP has completed the matches. Worklist items are available for display or further processing.
Refused	Out of Resources	A700H	The association is aborted using A-ABORT and the worklist is empty. The status meaning is logged.
Failed	Identifier does not match SOP Class	A900H	
Failed	Unable to Process	CxxxH	
Cancel	Matching terminated due to Cancel request	FE00H	If the query was cancelled due to too many worklist items then the SCP has completed the matches. Worklist items are available for display or further processing. The status meaning is logged.
Pending	Matches are continuing	FF00H	The worklist item contained in the identifier is collected for later display or further processing.
Pending	Matches are continuing – Warning that one or more Optional Keys were not supported	FF01H	
*	*	Any other status code.	The association is aborted using A-ABORT and the worklist is empty. The status meaning is logged.

The behavior of the MWM SCU AE during communication failure is summarized in the table below.

Table 4.2-29
MODALITY WORKLIST COMMUNICATION FAILURE BEHAVIOR

Exception	Behavior
Timeout	The association is aborted using A-ABORT and the worklist is empty. The reason is logged.
Association aborted by the SCP or network layers	The worklist is empty and the reason is logged.

Acquired images will always use the Study Instance UID specified for the Scheduled Procedure Step (if available). If an acquisition is unscheduled, a Study Instance UID will be generated locally.

The table below provides a description of the MWM SCU AE Worklist Request identifier and specifies the attributes that are copied into the images. Unexpected attributes returned in a C-FIND response are ignored.

Table 4.2-30
WORKLIST REQUEST IDENTIFIER

Module Name Attribute Name	Tag	VR	M	R	D	IOD
SOP Common						
Specific Character Set	(0008,0005)	CS		x		x
Scheduled Procedure Step						
Scheduled Procedure Step Sequence	(0040,0100)	SQ		x		
> Scheduled Station AE Title	(0040,0001)	AE	(S)	x	x	
> Scheduled Station Name	(0040,0010)	SH	S	x		
> Scheduled Procedure Step Location	(0040,0011)	SH	S	x	x	
> Scheduled Procedure Step Start Date	(0040,0002)	DA	R	x	x	
> Scheduled Procedure Step Start Time	(0040,0003)	TM		x	x	
> Scheduled Performing Physician's Name	(0040,0006)	PN		x	x	x
> Scheduled Procedure Step Description	(0040,0007)	LO		x	x	x
> Scheduled Protocol Code Sequence	(0040,0008)	SQ		x	x	x
> Scheduled Procedure Step ID	(0040,0009)	SH		x	x	x
> Modality	(0008,0060)	CS	(S)	x	x	x
> Requested Contrast Agent	(0032,1070)	LO		x		
> Pre-Medication	(0040,0012)	LO		x		
Requested Procedure						
Requested Procedure ID	(0040,1001)	SH		x	x	x
Requested Procedure Comments	(0040,1400)	LT		x	x	
Requested Procedure Code Sequence	(0032,1064)	SQ		x	x	
Referenced Study Sequence	(0008,1110)	SQ		x		x
Requested Procedure Description	(0032,1060)	LO		x	x	x
Study Instance UID	(0020,000D)	UI		x	x	x
Names of Intended Recipients of Results	(0040,1010)	PN		x	x	
Imaging Service Request						
Imaging Service Request Comments	(0040,2400)	LT		x	x	
Requesting Physician	(0032,1032)	PN		x	x	
Referring Physician's Name	(0008,0090)	PN		x	x	x
Requesting Service	(0032,1033)	LO		x	x	
Accession Number	(0008,0050)	SH		x	x	x
Visit Status						
Current Patient Location	(0038,0300)	LO		x	x	
Visit Relationship						
Referenced Patient Sequence	(0008,1120)	SQ		x		
Patient Identification						
Patient's Name	(0010,0010)	PN		x	x	x
Patient ID	(0010,0020)	LO	S	x	x	x
Other Patient IDs	(0010,1000)	LO		x	x	
Patient Demographic						
Patient's Birth Date	(0010,0030)	DA		x	x	x
Patient's Sex	(0010,0040)	CS		x	x	x
Patient's Size	(0010,1020)	DS		x	x	
Patient's Weight	(0010,1030)	DS		x	x	
Ethnic Group	(0010,2160)	SH		x	x	
Patient Comment	(0010,4000)	LT		x	x	x

Patient Medical						
Medical Alerts	(0010,2000)	LO		x	x	
Additional Patient History	(0010,21B0)	LT		x	x	
Pregnancy Status	(0010,21C0)	US		x	x	
Other						
Contributing Equipment Sequence	(0040,0321)	SQ				
>Institution Name	(0008,0080)	LO		x		x
>Institution Address	(0008,0081)	ST		x		x
>Institutional Department Name	(0008,1040)	LO		x		x
Performing Physician's Name	(0008,1050)	PN		x	x	x
Name of Physician Reading Study	(0008,1060)	PN		x		x
Operator's Name	(0008,1070)	PN		x	x	x

The above table should be read as follows:

- Module Name:** The name of the associated module for supported worklist attributes.
- Attribute Name:** Attributes supported to build the MWM SCU AE Worklist Request identifier.
- Tag:** DICOM tag for this attribute.
- VR:** DICOM VR for this attribute.
- M:** Matching keys for (automatic) Worklist Update. An "S" will indicate that the MWM SCU AE will supply an attribute value for Single Value Matching. A "(S)" will indicate that NULL attribute value may be set by the user and "R" will indicate Range Matching.
- R:** Return keys. An "x" will indicate that the MWM SCU AE will supply this attribute as Return Key with zero length for Universal Matching.
- D:** Displayed keys. An "x" indicates that this worklist attribute is displayed to the user during a patient registration. For example, Patient Name will be displayed when registering the patient prior to an examination. However some of displayed keys, for example Patient's Size and Patient's Weight, are not displayed after an examination.
- IOD:** An "x" indicates that this Worklist attribute is included into all Object Instances created during performance of the related Procedure Step.

4.2.3.4 Association Acceptance Policy

The MWM SCU AE does not accept associations.

4.2.4 MPPS SCU AE Specification

4.2.4.1 SOP Classes

The MPPS SCU AE provides Standard Conformance to the following SOP Classes:

Table 4.2-31
SOP CLASSES FOR THE MPPS SCU AE

SOP Class Name	SOP Class UID	SCU	SCP
Modality Performed Procedure Step	1.2.840.10008.3.1.2.3.3	Yes	No

4.2.4.2 Association Policies

4.2.4.2.1 General

The DICOM standard application context name for DICOM 3.0 is always proposed:

Table 4.2-32
DICOM APPLICATION CONTEXT FOR THE MPPS SCU AE

Application Context Name	1.2.840.10008.3.1.1.1
--------------------------	-----------------------

4.2.4.2.2 Number of Associations

The MPPS SCU AE initiates one association at a time.

Table 4.2-33
NUMBER OF ASSOCIATIONS INITIATED FOR THE MPPS SCU AE

Maximum number of simultaneous associations	1
---	---

4.2.4.2.3 Asynchronous Nature

The MPPS SCU AE does not support asynchronous communication (multiple outstanding transactions over a single association).

Table 4.2-34
ASYNCHRONOUS NATURE FOR THE MPPS SCU AE

Maximum number of outstanding asynchronous transactions	1
---	---

4.2.4.2.4 Implementation Identifying Information

The implementation information for this Application Entity is:

Table 4.2-35
DICOM IMPLEMENTATION CLASS AND VERSION FOR THE MPPS SCU AE

Implementation Class UID	2.16.840.1.113669.632.3.1.1.2.7
Implementation Version Name	Harmony

4.2.4.3 Association Initiation Policy

4.2.4.3.1 Activity – Acquire Images

4.2.4.3.1.1 Description and Sequencing of Activities

The MPPS SCU AE performs the creation of an MPPS Instance automatically when the user selects and starts a worklist item. Further updates on the MPPS data can be performed when the user completes the acquisition.

The MPPS SCU AE will initiate an association to issue an:

- N-CREATE request according to the CREATE Modality Performed Procedure Step SOP Instance operation, or an:
- N-SET request to update the contents and state of the MPPS according to the SET Modality Performed Procedure Step Information operation.

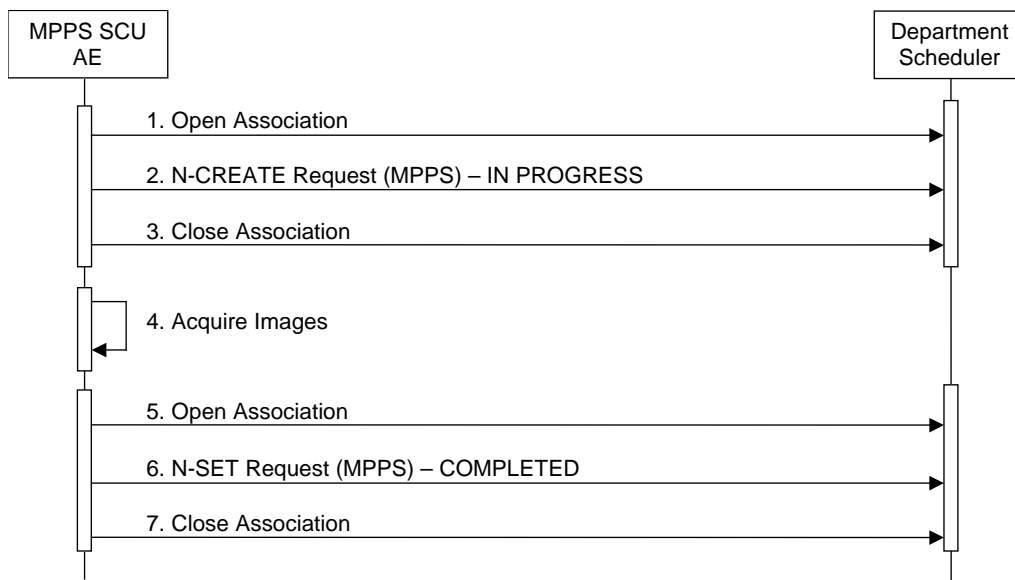

Figure 4.2-5
SEQUENCING OF ACTIVITY – ACQUIRE IMAGES

A possible sequence of interactions between the MPPS SCU AE and a Department Scheduler (e.g. a device such as a RIS or HIS which supports the MPPS SOP Class as an SCP) is illustrated in the Figure above:

1. The MPPS SCU AE opens an association with the Department Scheduler
2. The MPPS SCU AE sends an N-CREATE request to the Department Scheduler to create an MPPS Instance with status of “IN PROGRESS” and create all necessary attributes. The Department Scheduler acknowledges the MPPS creation with an N-CREATE response (status success).
3. The MPPS SCU AE closes the association with the Department Scheduler.
4. All images are acquired and stored in the local database.
5. The MPPS SCU AE opens an association with the Department Scheduler.
6. The MPPS SCU AE sends an N-SET request to the Department Scheduler to update the MPPS instance with status of “COMPLETED” and set all necessary attributes. The Department Scheduler acknowledges the MPPS update with an N-SET response (status success).
7. The MPPS SCU AE closes the association with the Department Scheduler.

4.2.4.3.1.2 Proposed Presentation Contexts

The MPPS SCU AE will propose Presentation Contexts as shown in the following table:

Table 4.2-36
PROPOSED PRESENTATION CONTEXTS FOR REAL-WORLD ACTIVITY ACQUIRE IMAGES

Presentation Context Table					
Abstract Syntax		Transfer Syntax		Role	Ext. Neg.
Name	UID	Name List	UID List		
Modality Performed Procedure Step	1.2.840.10008.3.1.2.3.3	Implicit VR Little Endian Explicit VR Little Endian	1.2.840.10008.1.2 1.2.840.10008.1.2.1	SCU	None

4.2.4.3.1.3 SOP Specific Conformance for MPPS SOP Class

The MPPS SCU AE provides standard conformance to the Modality Performed Procedure Step SOP Class as an SCU.

The behavior of the MPPS SCU AE when encountering status codes in an MPPS N-CREATE or N-SET response is summarized in the table below.

Table 4.2-37
MPPS N-CREATE / N-SET RESPONSE STATUS HANDLING BEHAVIOR

Service Status	Further Meaning	Status Code	Behavior
Success	Success	0000	The SCP has completed the operation successfully.
Failure	Processing Failure – Performed Procedure Step Object may no longer be updated	0110H	The association is aborted and the MPPS is marked as failed. The status meaning is logged and reported to the user.
Warning	Attribute Value Out of Range	0116H	
*	*	Any other status code.	

The behavior of the MPPS SCU AE during communication failure is summarized in the table below:

Table 4.2-38
MPPS COMMUNICATION FAILURE BEHAVIOR

Exception	Behavior
Timeout	The association is aborted and the MPPS is marked as failed. The reason is logged and reported to the user.
Association aborted by the SCP or network layers	The MPPS is marked as failed. The reason is logged and reported to the user.

The table below provides a description of the MPPS N-CREATE and N-SET request identifiers sent by the MPPS SCU AE. Empty cells in the N-CREATE and N-SET columns indicate that the attribute is not sent. An "x" indicates that an appropriate value will be sent. A "Zero length" attribute will be sent with zero length.

**Table 4.2-39
MPPS N-CREATE / N-SET REQUEST IDENTIFIER**

Attribute Name	Tag	VR	N-CREATE	N-SET
Specific Character Set	(0008,0005)	CS	Created, if an extended or replacement character set is used.	Created, if an extended or replacement character set is used.
Performed Procedure Step Relationship				
Scheduled Step Attributes Sequence	(0040,0270)	SQ	Always Set	
> Study Instance UID	(0020,000D)	UI	From Modality Worklist	
> Accession Number	(0008,0050)	SH	From Modality Worklist	
> Requested Procedure ID	(0040,1001)	SH	From Modality Worklist	
> Requested Procedure Description	(0032,1060)	LO	From Modality Worklist	
> Scheduled Procedure Step ID	(0040,0009)	SH	From Modality Worklist	
> Scheduled Procedure Step Description	(0040,0007)	LO	From Modality Worklist	
> Scheduled Protocol Code Sequence	(0040,0008)	SQ	From Modality Worklist	
>> Code Value	(0008,0100)	SH	From Modality Worklist	
>> Coding Scheme Designator	(0008,0102)	SH	From Modality Worklist	
>> Coding Scheme Version	(0008,0103)	SH	From Modality Worklist	
>> Code Meaning	(0008,0104)	LO	From Modality Worklist	
Patient's Name	(0010,0010)	PN	From Modality Worklist or user input	
Patient ID	(0010,0020)	LO	From Modality Worklist or user input.	
Patient's Birth Date	(0010,0030)	DA	From Modality Worklist or user input.	
Patient's Sex	(0010,0040)	CS	From Modality Worklist or user input.	
Referenced Patient Sequence	(0008,1120)	SQ	From Modality Worklist.	
Performed Procedure Step Information				
Performed Procedure Step ID	(0040,0253)	SH	Automatically created.	
Performed Station AE Title	(0040,0241)	AE	MPPS AE Title	
Performed Station Name	(0040,0242)	SH	From configuration	
Performed Location	(0040,0243)	SH	From configuration	
Performed Procedure Step Start Date	(0040,0244)	DA	Actual start date	
Performed Procedure Step Start Time	(0040,0245)	TM	Actual start time	
Performed Procedure Step Status	(0040,0252)	CS	IN PROGRESS	COMPLETED or DISCONTINUED
Performed Procedure Step Description	(0040,0254)	LO	From Modality Worklist.	
Performed Procedure Type Description	(0040,0255)	LO	From Modality Worklist or user input.	x

Procedure Code Sequence	(0008,1032)	SQ	Zero or more items	Zero or more items
> Code Value	(0008,0100)	SH	From Modality Worklist	From Modality Worklist
> Coding Scheme Designator	(0008,0102)	SH	From Modality Worklist	From Modality Worklist
> Coding Scheme Version	(0008,0103)	SH	From Modality Worklist	From Modality Worklist
> Code Meaning	(0008,0104)	LO	From Modality Worklist	From Modality Worklist
Performed Procedure Step End Date	(0040,0250)	DA	Zero length	Actual end date
Performed Procedure Step End Time	(0040,0251)	TM	Zero length	Actual end time
Image Acquisition Results				
Modality	(0008,0060)	CS	From Modality Worklist	
Patient's Name	(0010,0010)	PN	From Modality Worklist	
Patient ID	(0010,0020)	LO	From Modality Worklist	
Patient's Birth Date	(0010,0030)	DA	From Modality Worklist	
Patient's Sex	(0010,0040)	CS	From Modality Worklist	
Study ID	(0020,0010)	SH	Zero length	
Performed Protocol Code Sequence	(0040,0260)	SQ	Zero length	Zero or more items
> Code Value	(0008,0100)	SH		x
> Coding Scheme Designator	(0008,0102)	SH		x
> Coding Scheme Version	(0008,0103)	SH		x
> Code Meaning	(0008,0104)	LO		x
Performed Series Sequence	(0040,0340)	SQ	Zero length	One or more items
> Retrieve AE Title	(0008,0054)	AE		Zero length
> Series Description	(0008,103E)	LO		x
> Performing Physician's Name	(0008,1050)	PN		From Modality Worklist
> Operators' Name	(0008,1070)	PN		From Modality Worklist or user input
> Referenced Image Sequence	(0008,1140)	SQ		One or more items
>> Referenced SOP Class UID	(0008,1150)	UI		x
>> Referenced SOP Instance UID	(0008,1155)	UI		x
> Protocol Name	(0018,1030)	LO		x
> Series Instance UID	(0020,000E)	UI		x
> Referenced Non-Image Composite SOP Instance Sequence	(0040,0220)	SQ		x
Radiation Dose Module				
Distance Source to Detector	(0018,1110)	DS		x
Total Time of Fluoroscopy	(0040,0300)	US		x
Total Number of Exposures	(0040,0301)	US		x
Entrance Dose	(0040,0302)	US		x
Distance Source to Entrance	(0040,0306)	DS		x
Exposure Dose Sequence	(0040,030E)	SQ		Zero or more items
> KVP	(0018,0060)	DS		x
> Exposure Time	(0018,1150)	IS		x
> X-ray Tube Current in micro A	(0018,8151)	IS		x
Image Area Dose Product	(0018,115E)	DS		x
Entrance Dose in mGy	(0040,8302)	DS		x

Billing and Material Code				
Film Consumption Sequence	(0040,0321)	SQ	Zero length	Zero or more items
>Number of Films	(2100,0170)	IS		x
>Medium Type	(2000,0030)	CS		x
>Film Size ID	(2010,0050)	CS		x
Other				
Contributing Equipment Sequence	(0040,0321)	SQ		
>Institution Name	(0008,0080)	LO	From Modality Worklist	From Modality Worklist
>Institution Address	(0008,0081)	ST	From Modality Worklist	From Modality Worklist
>Institutional Department Name	(0008,1040)	LO	From Modality Worklist	From Modality Worklist
Performing Physician's Name	(0008,1050)	PN	From Modality Worklist or user input.	From Modality Worklist or user input.
Name of Physician Reading Study	(0008,1060)	PN	From Modality Worklist	From Modality Worklist
Operator's Name	(0008,1070)	PN	From Modality Worklist or user input.	From Modality Worklist or user input.

4.2.4.4 Association Acceptance Policy

The MPPS SCU AE does not accept associations.

4.2.5 Print SCU AE Specification

4.2.5.1 SOP Classes

The Print SCU AE provides Standard Conformance to the following Meta SOP Classes:

Table 4.2-40
META SOP CLASSES FOR THE PRINT SCU AE

SOP Class Name	SOP Class UID	SCU	SCP
Basic Grayscale Print Management Meta	1.2.840.10008.5.1.1.9	Yes	No

The above Meta SOP Classes are defined by the following set of supported SOP Classes:

Table 4.2-41
SOP CLASSES FOR THE PRINT SCU AE

SOP Class Name	SOP Class UID	SCU	SCP
Basic Film Session SOP Class	1.2.840.10008.5.1.1.1	Yes	No
Basic film Box SOP Class	1.2.840.10008.5.1.1.2	Yes	No
Basic Grayscale Image Box SOP Class	1.2.840.10008.5.1.1.4	Yes	No
Printer SOP Class	1.2.840.10008.5.1.1.16	Yes	No

4.2.5.2 Association Policies

4.2.5.2.1 General

The DICOM standard application context name for DICOM 3.0 is always proposed:

Table 4.2-42
DICOM APPLICATION CONTEXT FOR THE PRINT SCU AE

Application Context Name	1.2.840.10008.3.1.1.1
--------------------------	-----------------------

4.2.5.2.2 Number of Associations

The Print SCU AE initiates one association at a time.

Table 4.2-43
NUMBER OF ASSOCIATIONS INITIATED FOR THE PRINT SCU AE

Maximum number of simultaneous associations	1
---	---

4.2.5.2.3 Asynchronous Nature

The Print SCU AE does not support asynchronous communication (multiple outstanding transactions over a single association).

Table 4.2-44
ASYNCHRONOUS NATURE FOR THE PRINT SCU AE

Maximum number of outstanding asynchronous transactions	1
---	---

4.2.5.2.4 Implementation Identifying Information

The implementation information for the Print SCU AE is:

**Table 4.2-45
DICOM IMPLEMENTATION CLASS AND VERSION FOR THE PRINT SCU AE**

Implementation Class UID	2.16.840.1.113669.632.3.1.1.2.7
Implementation Version Name	Harmony

4.2.5.3 Association Initiation Policy

4.2.5.3.1 Activity – Send Images & Print Management Information

4.2.5.3.1.1 Description and Sequencing of Activities

A user composes images onto film sheets and requests them to be sent to a specific hardcopy device. The user can select the desired film format and number of copies.

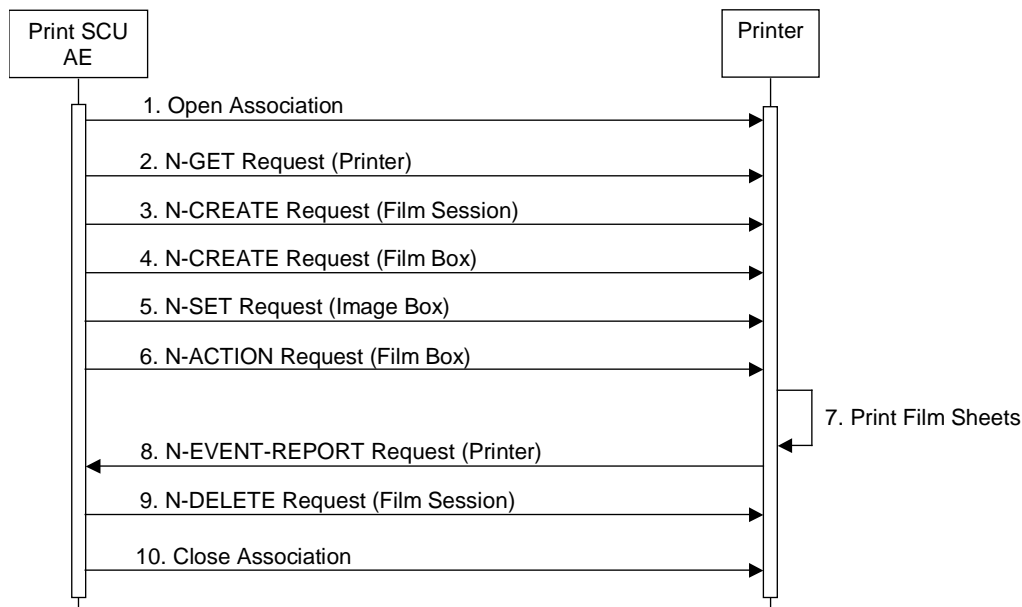

Figure 4.2-6
SEQUENCING OF ACTIVITY – SEND IMAGES & PRINT MANAGEMENT INFORMATION

A typical sequence of DIMSE messages sent over an association between the Print SCU AE and a Printer is illustrated in the Figure above:

1. The Print SCU AE opens an association with the Printer.
2. N-GET on the Printer SOP Class is used to obtain current printer status information.
3. N-CREATE on the Film Session SOP Class creates a Film Session.
4. N-CREATE on the Film Box SOP Class creates a Film Box linked to the Film Session.
5. N-SET on the Image Box SOP Class transfers the contents of the film sheet to the printer.
6. N-ACTION on the Film Box SOP Class instructs the Printer to print the Film Box
7. The Printer prints the requested number of film sheets.
8. The Printer asynchronously reports its status via N-EVENT-REPORT notification (Printer SOP Class). The printer can send this message at any time. The Print SCU AE does not require the N-EVENT-REPORT to be sent. The Print SCU AE is capable of receiving an N-EVENT-REPORT notification at any time during an association.
9. N-DELETE on the Film Session SOP Class deletes the complete Film Session SOP Instance hierarchy.
10. The Print SCU AE closes the association with the Printer.

4.2.5.3.1.2 Proposed Presentation Contexts

The Print SCU AE is capable of proposing the Presentation Contexts shown in the table below:

**Table 4.2-46
PROPOSED PRESENTATION CONTEXTS FOR ACTIVITY
SEND IMAGES & PRINT MANAGEMENT INFORMATION**

Presentation Context Table					
Abstract Syntax		Transfer Syntax		Role	Ext. Neg.
Name	UID	Name List	UID List		
Basic Grayscale Print Management Meta	1.2.840.10008.5.1.1.9	Implicit VR Little Endian Explicit VR Little Endian	1.2.840.10008.1.2 1.2.840.10008.1.2.1	SCU	None

4.2.5.3.1.3 Common SOP Specific Conformance for all Print SOP Classes

The general behavior of the Print SCU AE during communication failure is summarized in the table below. This behavior is common for all SOP Classes supported by the Print SCU AE.

**Table 4.2-47
PRINT COMMUNICATION FAILURE BEHAVIOR**

Exception	Behavior
Timeout	The association is aborted and the print-job is marked as failed. The reason is logged and the job failure is reported to the user via the job control application.
Association aborted by the SCP or network layers	The print-job is marked as failed. The reason is logged and the job failure is reported to the user via the job control application.

4.2.5.3.1.4 SOP Specific Conformance for Printer SOP Class

The Print SCU AE supports the following DIMSE operations and notifications for the Printer SOP Class:

- N-GET
- N-EVENT-REPORT

Details of the supported attributes and status handling behavior are described in the following subsections.

4.2.5.3.1.4.1 Printer SOP Class Operations (N-GET)

The Print SCU AE uses the Printer SOP Class N-GET operation to obtain information about the current printer status. The attributes obtained via N-GET are listed in the table below:

**Table 4.2-48
PRINTER SOP CLASS N-GET REQUEST ATTRIBUTES**

Attribute Name	Tag	VR	Value	Presence of Value	Source
Printer Status	(2110,0010)	CS	Provided by Printer	ALWAYS	Printer
Printer Status Info	(2110,0020)	CS	Provided by Printer	ALWAYS	Printer

The Printer Status information is evaluated as follows:

1. If Printer status (2110,0010) is NORMAL, the print-job continues to be printed.
2. If Printer status (2110,0010) is FAILURE, the print-job is marked as failed. The contents of Printer Status Info (2110,0020) is logged and reported to the user via the job control application.
3. If Printer status (2110,0010) is WARNING, the print-job continues to be printed. The contents of Printer Status Info (2110,0020) is logged and reported to the user via the job control application.

The behavior of the Print SCU AE when encountering status codes in an N-GET response is summarized in the table below:

**Table 4.2-49
PRINTER SOP CLASS N-GET RESPONSE STATUS HANDLING BEHAVIOR**

Service Status	Further Meaning	Status Code	Behavior
Success	Success	0000	The request to get printer status information was success.
*	*	Any other status code.	The association is aborted using A-ABORT and print-job is marked as failed. The status meaning is logged and reported to the user.

4.2.5.3.1.4.2 Printer SOP Class Notifications (N-EVENT-REPORT)

The Print SCU AE is capable of receiving an N-EVENT-REPORT request at any time during an association.

The behavior of the Print SCU AE when receiving Event Types within the N-EVENT-REPORT is summarized in the table below:

**Table 4.2-50
PRINTER SOP CLASS N-EVENT-REPORT BEHAVIOUR**

Event Type Name	Event Type ID	Behavior
Normal	1	The print-job continues to be printed.
Warning	2	The print-job continues to be printed.
Failure	3	The print-job continues to be printed.
*	*	The print-job continues to be printed.

The reasons for returning specific status codes in an N-EVENT-REPORT response are summarized in the table below:

**Table 4.2-51
PRINTER SOP CLASS N-EVENT-REPORT RESPONSE STATUS REASONS**

Service Status	Further Meaning	Status Code	Reasons
Success	Success	0000	The notification event has been successfully received.

4.2.5.3.1.5 SOP Specific Conformance for the Film Session SOP Class

The Print SCU AE supports the following DIMSE operations for the Film Session SOP Class:

- N-CREATE
- N-DELETE

Details of the supported attributes and status handling behavior are described in the following subsections.

4.2.5.3.1.5.1 Film Session SOP Class Operations (N-CREATE)

The attributes supplied in an N-CREATE Request are listed in the table below:

Table 4.2-52
FILM SESSION SOP CLASS N-CREATE REQUEST ATTRIBUTES

Attribute Name	Tag	VR	Value	Presence of Value	Source
Number of Copies	(2000,0010)	IS	1 .. 99	ALWAYS	User
Print Priority	(2000,0020)	CS	LOW, MID, or HIGH	ALWAYS	User
Medium Type	(2000,0030)	CS	BLUE FILM, CLEAR FILM or PAPER	ALWAYS	User
Film Destination	(2000,0040)	CS	MAGAZINE or PROCESSOR	ALWAYS	User

The behavior of the Print SCU AE when encountering status codes in an N-CREATE response is summarized in the table below:

Table 4.2-53
FILM SESSION SOP CLASS N-CREATE RESPONSE STATUS HANDLING BEHAVIOR

Service Status	Further Meaning	Status Code	Behavior
Success	Success	0000	The SCP has completed the operation successfully.
Warning	Attribute Value Out of Range	0116H	The N-CREATE operation is considered successful.
Warning	Attribute List Error	0107H	
*	*	Any other status code.	The association is aborted and the print-job is marked as failed. The status meaning is logged and reported to the user.

4.2.5.3.1.5.2 Film Session SOP Class Operations (N-DELETE)

The behavior of the Print SCU AE when encountering status codes in an N-DELETE response is summarized in the table below:

Table 4.2-54
PRINTER SOP CLASS N-DELETE RESPONSE STATUS HANDLING BEHAVIOR

Service Status	Further Meaning	Status Code	Behavior
Success	Success	0000	The SCP has completed the operation successfully.
*	*	Any other status code.	The association is aborted using A-ABORT and the print-job is marked as failed. The status meaning is logged and reported to the user.

4.2.5.3.1.6 SOP Specific Conformance for the Film Box SOP Class

The Print SCU AE supports the following DIMSE operations for the Film Box SOP Class:

- N-CREATE
- N-ACTION

Details of the supported attributes and status handling behavior are described in the following subsections.

4.2.5.3.1.6.1 Film Box SOP Class Operations (N-CREATE)

The attributes supplied in an N-CREATE Request are listed in the table below:

**Table 4.2-55
FILM BOX SOP CLASS N-CREATE REQUEST ATTRIBUTES**

Attribute Name	Tag	VR	Value	Presence of Value	Source
Image Display Format	(2010,0010)	CS	STANDARD C,R	ALWAYS	Auto
Film Orientation	(2010,0040)	CS	PORTRAIT or LANDSCAPE	ALWAYS	User
Film Size ID	(2010,0050)	CS	8INX10IN, 10INX14IN, 14INX14IN, 10INX12IN, 11INX14IN, 14INX17IN, 24CMX24CM, 24CMX30CM	ALWAYS	User
Magnification Type	(2010,0060)	CS	REPLICATE, BILINEAR, CUBIC or NONE	ALWAYS	User
Smoothing Type	(2010,0080)	CS	Values are defined in Printer Conformance Statement	ALWAYS	User
Border Density	(2010,0100)	CS	BLACK or WHITE	ALWAYS	User
Empty Image Density	(2010,0110)	CS	BLACK or WHITE	ALWAYS	User
Min Density	(2010,0120)	CS	0 .. 9999	ALWAYS	User
Max Density	(2010,0130)	CS	0 .. 9999	ALWAYS	User
Trim	(2010,0140)	CS	YES or NO	ALWAYS	User
Configuration Information	(2010,0150)	ST	Values are defined in Printer Conformance Statement	ALWAYS	User
Referenced Film Session Sequence	(2010,0500)	SQ		ALWAYS	Auto
>Referenced SOP Class UID	(0008,1150)	UI	1.2.840.10008.5.1.1.1	ALWAYS	Auto
>Referenced SOP Instance UID	(0008,1155)	UI	From created Film Session SOP Instance	ALWAYS	Auto

The behavior of the Print SCU AE when encountering status codes in an N-CREATE response is summarized in the table below:

Table 4.2-56
FILM BOX SOP CLASS N-CREATE RESPONSE STATUS HANDLING BEHAVIOR

Service Status	Further Meaning	Status Code	Behavior
Success	Success	0000	The SCP has completed the operation successfully.
Warning	Requested Min Density or Max Density outside of printer's operating range	B605H	The N-CREATE operation is considered successful.
*	*	Any other status code.	The association is aborted and the print-job is marked as failed. The status meaning is logged and reported to the user.

4.2.5.3.1.6.2 Film Box SOP Class Operations (N-ACTION)

An N-ACTION Request is issued to instruct the Print SCP to print the contents of the Film Box. The Action Reply argument in an N-ACTION response is not evaluated.

The behavior of the Print SCU AE when encountering status codes in an N-ACTION response is summarized in the table below:

**Table 4.2-57
FILM BOX SOP CLASS N-ACTION RESPONSE STATUS HANDLING BEHAVIOR**

Service Status	Further Meaning	Status Code	Behavior
Success	Success	0000	The SCP has completed the operation successfully. The film has been accepted for printing.
Warning	Film Box SOP Instance hierarchy does not contain Image Box SOP Instances (empty page).	B603H	The N-ACTION operation is considered successful.
Warning	Image size is larger than Image Box size. The image has been demagnified.	B604H	
Warning	Image size is larger than Image Box size. The image has been cropped to fit.	B609H	The association is aborted and the print-job is marked as failed. The status meaning is logged and reported to the user.
Warning	Image size or Combined Print Image Size is larger than Image Box size. The image or combined Print Image has been decimated to fit.	B60AH	
Failure	Unable to create Print Job SOP Instance; print queue is full.	C602H	
Failure	Image size is larger than Image Box size.	C603H	
Failure	Combined Print Image Size is larger than Image Box size.	C613H	
*	*	Any other status code.	

4.2.5.3.1.7 SOP Specific Conformance for the Grayscale Image Box SOP Class

The Print SCU AE supports the following DIMSE operations for the Grayscale Image Box SOP Class:

— N-SET

Details of the supported attributes and status handling behavior are described in the following subsections.

4.2.5.3.1.7.1 Grayscale Image Box SOP Class Operations (N-SET)

The attributes supplied in an N-SET Request are listed in the table below:

Table 4.2-58
GRAYSCALE IMAGE BOX SOP CLASS N-SET REQUEST ATTRIBUTES

Attribute Name	Tag	VR	Value	Presence of Value	Source
Magnification Type	(2010,0060)	CS	REPLICATE, BILINEAR, CUBIC or NONE	ALWAYS	User
Smoothing Type	(2010,0080)	CS	Values are defined in Printer Conformance Statement	ALWAYS	User
Image Position	(2020,0010)	US	1 .. 20	ALWAYS	Auto
Polarity	(2020,0020)	CS	NORMAL	ALWAYS	Auto
Basic Grayscale Image Sequence	(2020,0110)	SQ		ALWAYS	Auto
>Samples Per Pixel	(0028,0002)	US	1	ALWAYS	Auto
>Photometric Interpretation	(0028,0004)	CS	MONOCHROME2	ALWAYS	Auto
>Rows	(0028,0010)	US	1024	ALWAYS	Auto
>Columns	(0028,0011)	US	1024 or 1280	ALWAYS	Auto
>Pixel Aspect Ratio	(0028,0034)	IS	1\1	ALWAYS	Auto
>Bits Allocated	(0028,0100)	US	8	ALWAYS	Auto
>Bits Stored	(0028,0101)	US	8	ALWAYS	Auto
>High Bit	(0028,0102)	US	7	ALWAYS	Auto
>Pixel Representation	(0028,0103)	US	0	ALWAYS	Auto
>Pixel Data	(7FE0,0010)	OW		ALWAYS	Auto

The behavior of the Print SCU AE when encountering status codes in an N-SET response is summarized in the table below:

**Table 4.2-59
GRAYSCALE IMAGE BOX SOP CLASS N-SET RESPONSE STATUS HANDLING BEHAVIOR**

Service Status	Further Meaning	Status Code	Behavior
Success	Success	0000	The SCP has completed the operation successfully. Image successfully stored in Image Box.
Warning	Image size is larger than Image Box size. The image has been demagnified.	B604H	The N-SET operation is considered successful.
Warning	Requested Min Density or Max Density outside of printer's operating range.	B605H	
Warning	Image size is larger than Image Box size. The image has been cropped to fit.	B609H	The association is aborted and the print-job is marked as failed. The status meaning is logged and reported to the user.
Warning	Image size or Combined Print Image Size is larger than Image Box size. The image or combined Print Image has been decimated to fit.	B60AH	
Failure	Image size is larger than Image Box size.	C603H	
Failure	Insufficient memory in printer to store the image.	C605H	
Failure	Combined Print Image Size is larger than Image Box size.	C613H	
*	*	Any other status code.	

4.2.5.4 Association Acceptance Policy

The Print SCU AE does not accept associations.

4.2.6 Verification SCU AE Specification

4.2.6.1 SOP Classes

The Verification SCU AE provides Standard Conformance to the following SOP Classes:

Table 4.2-60
SOP CLASSES FOR THE VERIFICATION SCU AE

SOP Class Name	SOP Class UID	SCU	SCP
Verification	1.2.840.10008.1.1	Yes	No

4.2.6.2 Association Policies

4.2.6.2.1 General

The DICOM standard application context name for DICOM 3.0 is always proposed:

Table 4.2-61
DICOM APPLICATION CONTEXT FOR THE VERIFICATION SCU AE

Application Context Name	1.2.840.10008.3.1.1.1
--------------------------	-----------------------

4.2.6.2.2 Number of Associations

The Verification SCU AE initiates one association at a time.

Table 4.2-62
NUMBER OF ASSOCIATIONS INITIATED FOR THE VERIFICATION SCU AE

Maximum number of simultaneous associations	1
---	---

4.2.6.2.3 Asynchronous Nature

The Verification SCU AE does not support asynchronous communication (multiple outstanding transactions over a single association).

Table 4.2-63
ASYNCHRONOUS NATURE FOR THE VERIFICATION SCU AE

Maximum number of outstanding asynchronous transactions	1
---	---

4.2.6.2.4 Implementation Identifying Information

The implementation information for the Verification SCU AE is:

Table 4.2-64
DICOM IMPLEMENTATION CLASS AND VERSION FOR THE VERIFICATION SCU AE

Implementation Class UID	2.16.840.1.113669.632.3.1.1.2.7
Implementation Version Name	Harmony

4.2.6.3 Association Initiation Policy

4.2.6.3.1 Activity – Verify Connectivity

4.2.6.3.1.1 Description and Sequencing of Activities

The Verification SCU AE attempts to initiate a new association in order to issue a verification request (C-ECHO) if needed.

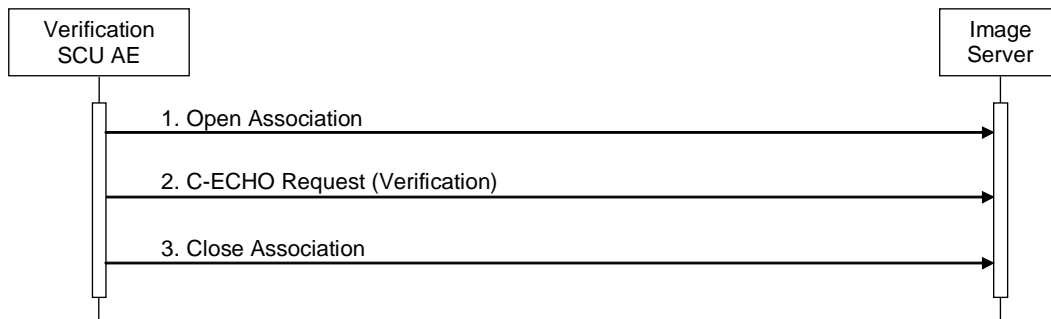

Figure 4.2-7
SEQUENCING OF ACTIVITY – VERIFY CONNECTIVITY

A possible sequence of interactions between the Verification SCU AE and an Image Server is illustrated in the Figure above:

1. The Verification SCU AE opens an association with the Image Server.
2. The Verification SCU AE issues a verification request (C-ECHO) and the Image Server replies with a C-ECHO response (status success).
3. The Verification SCU AE closes the association with the Image Server.

4.2.6.3.1.2 Proposed Presentation Contexts

The Verification SCU AE will propose the Presentation Contexts shown in the following table:

Table 4.2-65
PROPOSED PRESENTATION CONTEXTS FOR ACTIVITY VERIFY CONNECTIVITY

Presentation Context Table					
Abstract Syntax		Transfer Syntax		Role	Ext. Neg.
Name	UID	Name List	UID List		
Verification	1.2.840.10008.1.1	Implicit VR Little Endian Explicit VR Little Endian	1.2.840.10008.1.2 1.2.840.10008.1.2.1	SCU	None

4.2.6.3.1.3 SOP Specific Conformance for Verification SOP Class

The Verification SCU AE provides standard conformance to the Verification Service Class as an SCU.

The behavior of the Verification SCU AE when encountering status codes in a C-ECHO response is summarized in the table below:

**Table 4.2-66
VERIFICATION RESPONSE STATUS HANDLING BEHAVIOR**

Service Status	Further Meaning	Status Code	Behavior
Success	Success	0000	The Verification SCU AE judges the remote AE is present and active on the network.

The behavior of the Verification SCU AE during communication failure is summarized in the table below:

**Table 4.2-67
VERIFICATION COMMUNICATION FAILURE BEHAVIOR**

Exception	Behavior
Timeout	The association is aborted.
Association aborted by the SCP or network layers	The reason is logged.

4.3 NETWORK INTERFACES

4.3.1 Physical Network Interface

This Product supports a single network interface. One of the following physical network interfaces will be available as a standard:

Table 4.3-1
SUPPORTED PHYSICAL NETWORK INTERFACES

Ethernet 1000baseT
Ethernet 100baseT
Ethernet 10baseT

4.3.2 Additional Protocols

None.

4.4 CONFIGURATION

4.4.1 AE Title/Presentation Address Mapping

4.4.1.1 Local AE Titles

All local applications use the AE Titles and TCP/IP Ports configured via the Service Tool. The Field Service Engineer can configure the TCP Port via the Service Tool.

**Table 4.4-1
AE TITLE CONFIGURATION TABLE**

Application Entity	Default AE Title	Default TCP/IP Port
Storage SCU	ADR_STORAGE_SCU	Not Applicable
MWM SCU	ADR_MWM_SCU	
MPPS SCU	ADR_MPPS_SCU	
Print SCU	ADR_PRINT_SCU	
Verification SCU	ADR_VER_SCU	
Storage Commitment SCU	ADR_S_COMM_SCU	104 (For receiving C-ECHO and N-EVENT-REPORT)

4.4.1.2 Remote AE Title / Presentation Address Mapping

The AE Titles, host names and port numbers of remote applications are configured using the Service/Installation Tool.

4.4.2 Parameters

A large number of parameters related to acquisition and general operation can be configured using the Service/Installation Tool. The table below only shows those configuration parameters relevant to DICOM communication. See the Product's Service Manual for details on general configuration capabilities.

**Table 4.4-2
CONFIGURATION PARAMETERS TABLE**

Parameter	Configurable (Yes/No) [Range]	Default Value
General Parameters		
Max PDU Receive Size	Yes	32768 Bytes (32Kbytes)
Max PDU Send Size	[1-999999]	
Time-out waiting for a acceptance or rejection response to an Association Request (Application Level Timeout)	Yes [1-999999]	30 sec
Time-out waiting for a response to an association release request (Application Level Timeout)	Yes [1-999999]	30 sec
Time-out waiting for completion of a TCP/IP connect request (Low-level timeout)	Yes [1-999999]	30 sec
Time-out awaiting a Response to a DIMSE Request (Low-Level Timeout)	Yes [1-999999]	30 sec
Time-out for waiting for data between TCP/IP-packets (Low Level Timeout)	Yes [1-999999]	30 sec
Storage SCU Parameters		
Storage SCU time-out waiting for a response to a C-STORE-RQ	Yes [15-300]	180 sec
Number of times a failed send job may be retried	Yes [0-100] 0: Forever	10
Delay between retrying failed send jobs	Yes [0-1000] 0: Never retry	5 min
Maximum number of simultaneously initiated associations by the Storage SCU AE	No	1
Supported Transfer Syntaxes for Storage (separately configurable for each remote AE)	Yes	Explicit VR Little Endian
Storage Commitment SCU Parameters		
Storage Commitment SCU time-out waiting for a response to an N-ACTION-RQ	Yes [0-600]	180 sec
Number of times of a failed N-ACTION-RQ	Yes [0-1000]	5
Maximum number of simultaneously initiated Associations by the Storage Commitment SCU AE	No	1
Timeout waiting for a Storage Commitment Notification (maximum duration of applicability for a Storage Commitment Transaction UID).	Yes[0-24] hour 0: Forever	0
Maximum number of simultaneously accepted Associations by the Storage Commitment SCU AE	No	1
Delay association release after sending a Storage Commitment Request (wait for a Storage Commitment Notification over the same association).	No	0

Parameter	Configurable (Yes/No) [Range]	Default Value
Behavior when receiving N-EVENT Report - the Storage Commitment Request Successful.	Yes	Permit the operator (s) to delete the Instances
Modality Worklist SCU Parameters		
Maximum number of simultaneously initiated associations by the MWM SCU AE	No	1
Supported Transfer Syntaxes for MWM	Yes	Explicit VR Little Endian
Modality Worklist SCU time-out waiting for the final response to a C-FIND-RQ	Yes [0-600]	30 sec
Maximum number of Worklist Items	Yes	47
Query Worklist for specific Scheduled Station AE Title	Yes	ADR_MWM_SCU
Query Worklist for specific Modality Value	Yes	RF
MPPS SCU Parameters		
MPPS SCU time-out waiting for a response to an N-CREATE-RQ	Yes [0-600]	180sec
MPPS SCU time-out waiting for a response to an N-SET-RQ	Yes [0-600]	180sec
Maximum number of simultaneously initiated associations by the MPPS SCU AE	No	1
Supported Transfer Syntaxes for MPPS	Yes	Explicit VR Little Endian
Print SCU Parameters		
Print SCU time-out waiting for a response to an N-GET-RQ	Yes [15-300]	180sec
Print SCU time-out waiting for a response to an N-CREATE-RQ	Yes [15-300]	180sec
Print SCU time-out waiting for a response to an N-SET-RQ	Yes [15-300]	180sec
Print SCU time-out waiting for a response to an N-ACTION-RQ	Yes [15-300]	180sec
Maximum number of simultaneously initiated associations by the Print SCU AE	No	1
Supported Transfer Syntaxes for Print	Yes	Explicit VR Little Endian

5. MEDIA INTERCHANGE

5.1 IMPLEMENTATION MODEL

5.1.1 Application Data Flow

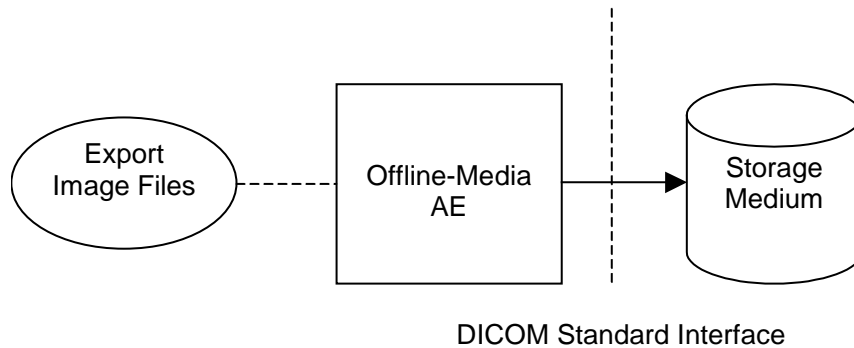

Figure 5.1-1
APPLICATION DATA FLOW DIAGRAM FOR MEDIA STORAGE

- The Offline-Media AE exports image files to a CD-R/DVD-R Storage medium. It is associated with the local real-world activity “Export Image Files” performed upon user request.

5.1.2 Functional Definition of AE

5.1.2.1 Functional Definition of Offline-Media AE

The Offline-Media AE is performed upon user request for selected studies/series/images to an offline DICOM CD-R/DVD-R medium. It therefore performs the following tasks:

Export:

- Builds DICOM Information Objects.
- Creates a DICOMDIR file that represents the contents of the DICOM Information Objects to be recorded.
- Records DICOM Information Objects and the DICOMDIR file to the CD-R/DVD-R medium.

5.1.3 Sequencing of Real-World Activities

5.1.3.1 Activity - Export Image Files

Operator requests to create new File-set(s) onto a new CD-R/DVD-R. The requests are placed in a queue and are executed in the foreground.

The operations for “Export Image Files” are described below:

- Step-1: Select the instance(s), series, studies, or patients on the local storage device to be created to the CD-R/DVD-R medium.
- Step-2: Select the CD-R/DVD-R image archiving.
- Step-3: Insert the CD/DVD media in the device.
- Step-4: Request to copy to the CD-R/DVD-R.

5.1.4 File Meta Information for Implementation Class and Version

The implementation information written to the File Meta Header in each file is:

**Table 5.1-1
DICOM IMPLEMENTATION CLASS AND VERSION FOR MEDIA STORAGE**

File Meta Information Version	1
Implementation Class UID	2.16.840.1.113669.632.3.1.1.2.7
Implementation Version Name	Harmony

5.2 AE SPECIFICATIONS

5.2.1 Offline-Media AE Specification

The Offline-Media AE provides standard conformance to the DICOM Interchange Option of the Media Storage Service Class. The Application Profiles and roles are listed below:

**Table 5.2-1
APPLICATION PROFILES, ACTIVITIES AND ROLES FOR OFFLINE-MEDIA**

Application Profiles Supported	Real World Activity	Role	SC Option
STD-GEN-CD	Export Image Files	FSC	Interchange

5.2.1.1 File Meta Information for the Application Entity

The Offline-Media AE does not set the Source Application Entity Title.

5.2.1.2 Real-World Activities

5.2.1.2.1 Activity – Export Image Files

The Offline-Media AE acts as an FSC using the interchange option when requested to export SOP Instances from the local database to a CD-R/DVD-R medium.

5.2.1.2.1.1 Media Storage Application Profiles

The Offline-Media AE supports the STD-GEN-CD Application Profile.

5.2.1.2.1.1.1 Options

The Offline-Media AE supports the SOP Classes and Transfer Syntaxes listed in the table below for the STD-GEN-CD Application Profile as an FSC.

Table 5.2-2
IODS, SOP CLASSES AND TRANSFER SYNTAXES FOR THE STD-GEN-CD PROFILE (FSC)

Information Object Definition	SOP Class UID	Transfer Syntax	Transfer Syntax UID
Media Storage Directory Storage	1.2.840.10008.1.3.10	Explicit VR Little Endian Uncompressed	1.2.840.10008.1.2.1
XA Image Storage	1.2.840.10008.5.1.4.1.1.12.1	Explicit VR Little Endian Uncompressed	1.2.840.10008.1.2.1
RF Image Storage	1.2.840.10008.5.1.4.1.1.12.2	Explicit VR Little Endian Uncompressed	1.2.840.10008.1.2.1
Secondary Capture Image Storage (Grayscale)	1.2.840.10008.5.1.4.1.1.7	Explicit VR Little Endian Uncompressed	1.2.840.10008.1.2.1

5.3 AUGMENTED AND PRIVATE APPLICATION PROFILES

5.3.1 Augmented Application Profiles

Not applicable to this product

5.3.2 Private Application Profiles

Not applicable to this product

5.4 MEDIA CONFIGURATION

Not applicable to this product

6. SUPPORT OF CHARACTER SETS

This product supports the following character sets:

- ISO-IR 6 (default) ISO646
- ISO-IR 87 (Japanese) JIS X 0208 (Kanji)

Character set ISO-IR 87 can be set to the tags listed in the table below;

Table 6-1
Tag lists for ISO-IR 87

Attribute Name	Tag	VR
Institution Name	(0080,0080)	LO
Referring Physician's Name	(0008,0090)	PN
Study Description	(0008,1030)	LO
Series Description	(0008,103E)	LO
Physician(s) of Record	(0008,1048)	PN
Performing Physician's Name	(0008,1050)	PN
Operators' Name	(0008,1070)	PN
Patient's Name	(0010,0010)	PN
Medical Alerts	(0010,2000)	LO
Ethnic Group	(0010,2160)	SH
Additional Patient History	(0010,21B0)	LT
Patient Comments	(0010,4000)	LT
Protocol Name	(0018,1030)	LO
Image Comments	(0020,4000)	LT
Requesting Physician	(0032,1032)	PN
Requesting Service	(0032,1033)	LO
Requested Procedure Description	(0032,1060)	LO
Scheduled Performing Physician's Name	(0040,0006)	PN
Scheduled Procedure Step Description	(0040,0007)	LO
Performed Procedure Step Description	(0040,0254)	LO
Performed Procedure Type Description	(0040,0255)	LO
Names of Intended Recipients of Results	(0040,1010)	PN
Requested Procedure Comments	(0040,1400)	LT
Imaging Service Request Comments	(0040,2400)	LT

7. SECURITY

This product does not support any specific security measures.

It is assumed that this product is used within a secured environment. It is assumed that a secured environment includes at a minimum:

- a. Firewall or router protections to ensure that only approved external hosts have network access to the product.
- b. Firewall or router protections to ensure that the product only has network access to approved external hosts and services.
- c. Any communication with external hosts and services outside the locally secured environment use appropriate secure network channels (e.g. such as a Virtual Private Network (VPN))

Other network security procedures such as automated intrusion detection may be appropriate in some environments. Additional security features may be established by the local security policy and are beyond the scope of this conformance statement.

8. ANNEXES

8.1 IOD CONTENTS

8.1.1 Created SOP Instances

Table 8.1-1 specifies the attributes of an XA Image transmitted by the Storage SCU AE.

Table 8.1-2 specifies the attributes of an RF Image transmitted by the Storage SCU AE.

Table 8.1-3 specifies the attributes of a Secondary Capture Image transmitted by the Storage SCU AE.

Table 8.1-4 specifies the attributes of a Dose SR transmitted by the Storage SCU AE.

The following tables use a number of abbreviations. The abbreviations used in the “Presence of ...” column are:

VNAP	Value Not Always Present (attribute sent zero length if no value is present)
ANAP	Attribute Not Always Present
ALWAYS	Always Present
EMPTY	Attribute is sent without a value

The abbreviations used in the “USAGE” column are:

M	the attribute value is Mandatory
C	the attribute value is Conditional
U	the attribute value is User Option

The abbreviations used in the “Source” column:

MWL	the attribute value source is from Modality Worklist
USER	the attribute value source is from User input
AUTO	the attribute value is generated automatically
CONFIG	the attribute value source is a configurable parameter

8.1.1.1 XA Image IOD

**Table 8.1-1
IOD OF CREATED XA IMAGE SOP INSTANCES**

IE	Module	Reference	Presence of Module	Usage
Patient	Patient	Table 8.1-5	ALWAYS	M
	Clinical Trial Subject		EMPTY	U
Study	General Study	Table 8.1-6	ALWAYS	M
	Patient Study	Table 8.1-7	ANAP	U
	Clinical Trial Study		EMPTY	U
Series	General Series	Table 8.1-8	ALWAYS	M
	Clinical Trial Series		EMPTY	U
Frame of Reference	Synchronization		EMPTY	U
Equipment	General Equipment	Table 8.1-9	ALWAYS	M
Image	General Image	Table 8.1-11	ALWAYS	M
	Image Pixel	Table 8.1-12	ALWAYS	M
	Contrast/Bolus		EMPTY	C
	Cine		EMPTY	C
	Multi-frame		EMPTY	C
	Frame Pointers		EMPTY	U
	Mask		EMPTY	C
	Display Shutter	Table 8.1-13	ANAP	U
	Device		EMPTY	U
	Intervention		EMPTY	U
	X-ray Image	Table 8.1-15	ALWAYS	M
	X-ray Acquisition	Table 8.1-16	ANAP	M
	X-ray Collimator		EMPTY	U
	X-ray Table	Table8.1-21	ANAP	C
	XA Positioner	Table 8.1-17	ANAP	M
	DX Detector		EMPTY	U
	Overlay Plane		EMPTY	U
	Multi-frame Overlay		EMPTY	C
	Modality LUT		EMPTY	C/U
	VOI LUT	Table 8.1-19	ALWAYS	U
SOP Common	Table 8.1-14	ALWAYS	M	

8.1.1.2 RF Image IOD

**Table 8.1-2
IOD OF CREATED RF IMAGE SOP INSTANCES**

IE	Module	Reference	Presence of Module	Usage
Patient	Patient	Table 8.1-5	ALWAYS	M
	Clinical Trial Subject		EMPTY	U
Study	General Study	Table 8.1-6	ALWAYS	M
	Patient Study	Table 8.1-7	ANAP	U
	Clinical Trial Study		EMPTY	U
Series	General Series	Table 8.1-8	ALWAYS	M
	Clinical Trial Series		EMPTY	U
Frame of Reference	Synchronization		EMPTY	U
Equipment	General Equipment	Table 8.1-9	ALWAYS	M
Image	General Image	Table 8.1-11	ALWAYS	M
	Image Pixel	Table 8.1-12	ALWAYS	M
	Contrast/Bolus		EMPTY	U
	Cine		EMPTY	U
	Multi-frame		EMPTY	U
	Frame Pointers		EMPTY	U
	Mask		EMPTY	U
	X-ray Image	Table 8.1-15	ALWAYS	M
	X-ray Acquisition	Table 8.1-16	ANAP	M
	X-ray Collimator		EMPTY	U
	Display Shutter	Table 8.1-13	ANAP	U
	Device		EMPTY	U
	Intervention		EMPTY	U
	X-ray Table	Table8.1-21	ANAP	U
	XRF Positioner	Table 8.1-18	ANAP	M
	X-Ray Tomo Acquisition		EMPTY	C
	DX Detector		EMPTY	U
	Overlay Plane		EMPTY	U
	Modality LUT		EMPTY	U
	VOI LUT	Table 8.1-19	ALWAYS	U
SOP Common	Table 8.1-14	ALWAYS	M	

8.1.1.3 SC Image IOD

**Table 8.1-3
IOD OF CREATED SC IMAGE SOP INSTANCES**

IE	Module	Reference	Presence of Module	Usage
Patient	Patient	Table 8.1-5	ALWAYS	M
	Clinical Trial Subject		EMPTY	U
Study	General Study	Table 8.1-6	ALWAYS	M
	Patient Study	Table 8.1-7	Only if "Patient's Age" is present	U
	Clinical Trial Study		EMPTY	U
Series	General Series	Table 8.1-8	ALWAYS	M
	Clinical Trial Series		EMPTY	U
Equipment	General Equipment	Table 8.1-9	ALWAYS	U
	SC Equipment	Table 8.1-10	ALWAYS	M
Image	General Image	Table 8.1-11	ALWAYS	M
	Image Pixel	Table 8.1-12	ALWAYS	M
	Device		EMPTY	U
	SC Image	Table 8.1-20	ALWAYS	M
	Overlay Plane		EMPTY	U
	Modality LUT		EMPTY	U
	VOI LUT	Table 8.1-19	ALWAYS	U
	SOP Common	Table 8.1-14	ALWAYS	M

8.1.1.4 DOSE SR IOD

**Table 8.1-4
IOD OF CREATED DOSE SR SOP INSTANCES**

IE	Module	Reference	Presence of Module	Usage
Patient	Patient	Table 8.1-5	ALWAYS	M
	Clinical Trial Subject		EMPTY	U
Study	General Study	Table 8.1-6	ALWAYS	M
	Patient Study		EMPTY	U
	Clinical Trial Study		EMPTY	U
Series	SR Document Series	Table 8.1-22	ALWAYS	M
	Clinical Trial Series		EMPTY	U
Equipment	General Equipment	Table 8.1-9	ALWAYS	M
	Enhanced GENERAL Equipment	Table 8.1-23	ALWAYS	M
Document	SR Document General	Table 8.1-24	ALWAYS	M
	SR Document Content	Table 8.1-25	ALWAYS	M
	SOP Common	Table 8.1-14	ALWAYS	M

8.1.1.5 Common Modules

**Table 8.1-5
PATIENT MODULE OF CREATED SOP INSTANCES**

Attribute Name	Tag	VR	Value	Presence of Value	Source
Referenced Patient Sequence	(0008,1120)	SQ	From Modality Worklist.	VNAP	MWL
>Referenced SOP Class UID	(0008,1150)	UI	From Modality Worklist.	VNAP	MWL
>Referenced SOP Instance UID	(0008,1155)	UI	From Modality Worklist.	VNAP	MWL
Patient's Name	(0010,0010)	PN	From Modality Worklist or user input. Ex.) "TOSHIBA^TAROMM=MM=^"	VNAP	MWL/ USER
Patient ID	(0010,0020)	LO	From Modality Worklist or user input. Ex.) "00000001"	ALWAYS	MWL/ USER
Patient's Birth Date	(0010,0030)	DA	From Modality Worklist or user input. Ex.) "20040103"	VNAP	MWL/ USER
Patient's Sex	(0010,0040)	CS	From Modality Worklist or user input. Ex.) "M "	VNAP	MWL/ USER
Other Patient Ids	(0010,1000)	LO	From Modality Worklist. Ex.) "90000001"	ANAP	MWL
Ethnic Group	(0010,2160)	AS	From Modality Worklist or user input. Ex.) "Japan "	ANAP	MWL
Patient Comments	(0010,4000)	LT	From Modality Worklist or user input. Comments of patient.	ANAP	MWL/ USER

**Table 8.1-6
GENERAL STUDY MODULE OF CREATED SOP INSTANCES**

Attribute Name	Tag	VR	Value	Presence of Value	Source
Study Date	(0008,0020)	DA	Ex.) "20091202"	VNAP	AUTO
Study Time	(0008,0030)	TM	Ex.) "105620.000"	VNAP	AUTO
Accession Number	(0008,0050)	SH	From Modality Worklist, generated by device or user input. Ex.) "123456"	ALWAYS	MWL/ AUTO
Referring Physician's Name	(0008,0090)	PN	From Modality Worklist or user input. Ex.) "TOSHIBA^TAROMM=MM=^"	VNAP	MWL
Study Description	(0008,1030)	LO	Ex.) "UPPER GI"	ANAP	USER
Physician(s) of Record	(0008,1048)	PN	From Modality Worklist. Ex.) "TOSHIBA^TAROMM=MM=^"	ANAP	MWL
Name of Physician Reading Study	(0008,1060)	PN	From Modality Worklist. Ex.) "TOSHIBA^TAROMM=MM=^"	ANAP	MWL
Referenced Study Sequence	(0008,1110)	SQ	From Modality Worklist.	ANAP	MWL
>Referenced SOP Class UID	(0008,1150)	UI	From Modality Worklist.	ANAP	MWL
>Referenced SOP Instance UID	(0008,1155)	UI	From Modality Worklist.	ANAP	MWL
Study Instance UID	(0020,000D)	UI	From Modality Worklist or generated by device. Ex.) "1.2.392.200036.9116.1.1.1.1.12 005634.20040401105559 "	ALWAYS	MWL/ AUTO
Study ID	(0020,0010)	SH	Ex.) "10"	VNAP	AUTO

Table 8.1-7
PATIENT STUDY MODULE OF CREATED SOP INSTANCES

Attribute Name	Tag	VR	Value	Presence of Value	Source
Patient's Age	(0010,1010)	AS	Ex.) "010Y"	ANAP	AUTO
Additional Patient History	(0010,21B0)	LT	From Modality Worklist. Ex.) "no prior records"	ANAP	MWL

**Table 8.1-8
GENERAL SERIES MODULE OF CREATED SOP INSTANCES**

Attribute Name	Tag	VR	Value	Presence of Value	Source
Series Date	(0008,0021)	DA	Ex.) "20091202"	ANAP	AUTO
Series Time	(0008,0031)	TM	Ex.) "105620.000"	ANAP	AUTO
Modality	(0008,0060)	CS	From Modality Worklist or user input. "XA " or "RF"	ALWAYS	MWL/ USER
Series Description	(0008,103E)	LO	Ex.) "Sequence"	ANAP	AUTO
Performing Physicians' Name	(0008,1050)	PN	From Modality Worklist or user input. Ex.) "TOSHIBA^TARO^M=M=M=L"	VNAP	MWL/ USER
Operator's Name	(0008,1070)	PN	From Modality Worklist or user input Ex.) "TOSHIBA^TARO^M=M=M=L"	VNAP	MWL/ USER
Referenced Performed Procedure	(0008,1111)	SQ		ANAP	MWL
>Referenced SOP Class UID	(0008,1150)	UI	Ex.) "1.2.840.10008.3.1.2.3.3 "	VNAP	AUTO
>Referenced SOP Instance UID	(0008,1155)	UI	Ex.) "2.16.840.1.113669.632.3.41293 470351098404569201083994418 38739517"	VNAP	AUTO
Body Part Examined	(0018,0015)	CS	Ex.) "SKULL " Text description of the part of the body examined. Defined Terms: SKULL CSPINE TSPINE LSPINE SSPINE COCCYX CHEST CLAVICLE BREAST ABDOMEN PELVIS HIP SHOULDER ELBOW KNEE ANKLE HAND FOOT EXTREMITY HEAD HEART NECK LEG ARM JAW	VNAP	USER
Protocol Name	(0018,1030)	LO	Ex.) "DR STANDARD "	VNAP	MWL/ USER

Series Instance UID	(0020,000E)	UI	Ex.) "1.2.392.200036.9116.1.1.1.1.12005634.20040401105559.1 "	ALWAYS	AUTO
Series Number	(0020,0011)	IS	Ex.) "1 "	VNAP	AUTO
Performed Procedure Step Start date	(0040,0244)	DT	Ex.) "20091202"	VNAP	AUTO
Performed Procedure Step Start time	(0040,0245)	TM	Ex.) "144442"	VNAP	AUTO
Performed Procedure Step ID	(0040,0253)	SH	Ex.) "DSA "	ALWAYS	AUTO
Performed Procedure Step Description	(0040,0254)	LO	From Modality Worklist. Ex.) "ABCDEFGG "	VNAP	MWL
Performed Protocol Code Sequence	(0040,0260)	SQ		VNAP	MWL
> Code Value	(0008,0100)	SH	From Modality Worklist. Ex.) "ABCD"	VNAP	MWL
> Coding Scheme Designator	(0008,0102)	SH	From Modality Worklist. Ex.) "ABCD"	VNAP	MWL
> Code Version	(0008,0103)	SH	From Modality Worklist. Ex.) "ABCD"	VNAP	MWL
> Code Meaning	(0008,0104)	LO	From Modality Worklist. Ex.) "ABCD"	VNAP	MWL
Request Attributes Sequence	(0040,0275)	SQ		VNAP	MWL
> Scheduled Procedure Step Description	(0040,0007)	LO	From Modality Worklist. Ex.) "ABCDEFGG "	ANAP	MWL
> Scheduled Protocol Code Sequence	(0040,0008)	SQ		VNAP	MWL
>> Code Value	(0008,0100)	SH	From Modality Worklist. Ex.) "ABCD"	VNAP	MWL
>> Coding Scheme Designator	(0008,0102)	SH	From Modality Worklist. Ex.) "ABCD"	VNAP	MWL
>> Code Version	(0008,0103)	SH	From Modality Worklist. Ex.) "ABCD"	VNAP	MWL
>> Code Meaning	(0008,0104)	LO	From Modality Worklist. Ex.) "ABCDEFGG "	VNAP	MWL
> Scheduled Procedure Step ID	(0040,0009)	SH	From Modality Worklist. Ex.) "ABCD"	VNAP	MWL
> Requested Procedure ID	(0040,1001)	SH	From Modality Worklist. Ex.) "ABCD"	VNAP	MWL

**Table 8.1-9
GENERAL EQUIPMENT MODULE OF CREATED SOP INSTANCES**

Attribute Name	Tag	VR	Value	Presence of Value	Source
Manufacturer	(0008,0070)	LO	"TOSHIBA "	VNAP	CONFIG
Institution Name	(0008,0080)	LO	Ex.) "TOSHIBA HOSP"	ANAP	MWL/ CONFIG
Institution Address	(0008,0081)	LO		ANAP	MWL
Station Name	(0008,1010)	SH	Ex.) "DR-TV "	ANAP	CONFIG
Institution Department Name	(0008,1040)	LO		ANAP	MWL
Manufacturer's Model Name	(0008,1090)	LO	Ex.) "Platinum43"	ANAP	AUTO
Device Serial Number	(0018,1000)	LO	Ex.) "RM0-106 "	ANAP	CONFIG
Software Version	(0018,1020)	LO	Ex.) "1.02.01 "	ANAP	CONFIG

**Table 8.1-10
SC EQUIPMENT MODULE OF CREATED SOP INSTANCES**

Attribute Name	Tag	VR	Value	Presence of Value	Source
Modality	(0008,0060)	LO	Ex.) "OT"	ANAP	AUTO
Conversion Type	(0008,0064)	LO	Ex.) "DI"	ANAP	AUTO

**Table 8.1-11
GENERAL IMAGE MODULE OF CREATED SOP INSTANCES**

Attribute Name	Tag	VR	Value	Presence of Value	Source
Image Type	(0008,0008)	CS	Ex.) "ORIGINAL\PRIMARY\SINGLE PLANE "	ANAP	AUTO
Acquisition Date	(0008,0022)	DA	Ex.) "105620.000"	VNAP	AUTO
Content Date	(0008,0023)	DA	Ex.) "20040402"	VNAP	AUTO
Study Time	(0008,0030)	TM	Ex.) "105620"	VNAP	AUTO
Series Time	(0008,0031)	TM	Ex.) "105620"	VNAP	AUTO
Acquisition Time	(0008,0032)	TM	Ex.) "105620"	VNAP	AUTO
Content Time	(0008,0033)	TM	Ex.) "105620"	VNAP	AUTO
Derivation Description	(0008,2111)	ST	Ex.) "Derivation Description:Filter,DCF,Windowing,Gamma Correction - WS."	ANAP	AUTO
Instance Number	(0020,0013)	IS	Ex.) "1 "	VNAP	AUTO
Patient Orientation	(0020,0020)	CS		EMPTY	AUTO
Images in Acquisition	(0020,1002)	IS	Ex.) "1 "	ALWAYS	AUTO
Image Comments	(0020,4000)	LT	Ex.) "TEST"	ANAP	USER
Burned In Annotation	(0028,0301)	CS	Ex.) "NO"	ANAP	USER
Lossy Image Compression	(0028,2110)	CS	Ex.) "00"	ANAP	AUTO

**Table 8.1-12
IMAGE PIXEL MODULE OF CREATED SOP INSTANCES**

Attribute Name	Tag	VR	Value	Presence of Value	Source
Samples per Pixel	(0028,0002)	US	Ex.) 1	ALWAYS	AUTO
Photometric Interpretation	(0028,0004)	CS	Ex.) "MONOCHROME2 "	ALWAYS	AUTO
Rows	(0028,0010)	US	Ex.) 1024	ALWAYS	AUTO
Columns	(0028,0011)	US	Ex.) 1024	ALWAYS	AUTO
Bits Allocated	(0028,0100)	US	16	ALWAYS	AUTO
Bits Stored	(0028,0101)	US	16 or 14 or 12	ALWAYS	AUTO
High Bit	(0028,0102)	US	15 or 13 or 11	ALWAYS	AUTO
Pixel Representation	(0028,0103)	US	0	ALWAYS	AUTO
Pixel Data	(7FE0,0010)	OW		ALWAYS	AUTO

**Table 8.1-13
DISPLAY SHUTTER MODULE OF CREATED SOP INSTANCES**

Attribute Name	Tag	VR	Value	Presence of Value	Source
Shutter Shape	(0018,1600)	CS	Ex.) "RECTANGULAR "	ANAP	USER
Shutter Left Vertical Edge	(0018,1602)	IS	Ex.) "237 "	ANAP	USER
Shutter Right Vertical Edge	(0018,1604)	IS	Ex.) "759 "	ANAP	USER
Shutter Upper Horizontal Edge	(0018,1606)	IS	Ex.) "0 "	ANAP	USER
Shutter Lower Horizontal Edge	(0018,1608)	IS	Ex.) "1023"	ANAP	USER
Shutter Presentation Value	(0018,1622)	US	Ex.) 0	ANAP	USER

**Table 8.1-14
SOP COMMON MODULE OF CREATED XARF IMAGE SOP INSTANCES**

Attribute Name	Tag	VR	Value	Presence of Value	Source
Specific Character Set	(0008,0005)	CS	Ex.) "\ISO 2022 IR 87 "	ANAP	CONFIG
SOP Class UID	(0008,0016)	UI	Ex.) "1.2.840.10008.5.1.4.1.1.12.2"	ALWAYS	CONFIG
SOP Instance UID	(0008,0018)	UI	Ex.) "1.2.392.200036.9116.1.1.1.1.120 05634.20040401105559 "	ALWAYS	AUTO
Instance Number	(0020,0013)	IS	Ex.) "1 "	ALWAYS	AUTO

8.1.1.6 XA/RF/SC Image Modules

**Table 8.1-15
X-RAY IMAGE MODULE OF CREATED XA/RF IMAGE SOP INSTANCES**

Attribute Name	Tag	VR	Value	Presence of Value	Source
Image Type	(0008,0008)	CS	Ex.) "DERIVED \neq SECONDARY \neq SINGLE PLANE"	ALWAYS	AUTO
Samples per Pixel	(0028,0002)	US	1	ALWAYS	AUTO
Photometric Interpretation	(0028,0004)	CS	"MONOCHROME2 "	ALWAYS	CONFIG
Bits Allocated	(0028,0100)	US	16	ALWAYS	CONFIG
Bits Stored	(0028,0101)	US	16 or 14 or 12	ALWAYS	CONFIG
High Bit	(0028,0102)	US	15 or 13 or 11	ALWAYS	CONFIG
Pixel Representation	(0028,0103)	US	0	ALWAYS	AUTO
Pixel Intensity Relationship	(0028,1040)	CS	Ex.) "DISP"	ALWAYS	AUTO
Lossy Image Compression	(0028,2110)	CS	Ex.) "00"	ANAP	AUTO
Derivation Description	(0008,2111)	ST	Ex.) "Derivation Description:Filter,DCF,Shutters,Windowing,Gamma Correction - WS."	ANAP	AUTO
Pixel Spacing	(0028,0030)	DS	Ex.) "0.140\0.140 "	ANAP	AUTO

**Table 8.1-16
X-RAY ACQUISITION MODULE OF CREATED XA/RF IMAGE SOP INSTANCES**

Attribute Name	Tag	VR	Value	Presence of Value	Source
KVP	(0018,0060)	DS	Ex.) "84"	ANAP	AUTO
Field of View Shape	(0018,1147)	CS	Ex.) "ROUND "	ANAP	AUTO
Exposure Time	(0018,1150)	IS	Ex.) "24"	ANAP	AUTO
X-ray Tube Current	(0018,1151)	IS	Ex.) "200 "	ANAP	AUTO
Radiation Setting	(0018,1155)	CS	Ex.) "GR"	ALWAYS	AUTO
Radiation Mode	(0018,115A)	CS	Ex.) "CONTINUOUS"	ANAP	AUTO
Image Area Dose Product	(0018,115E)	DS	Ex) "0 "	ANAP	AUTO
Intensifier Size	(0018,1162)	DS	Ex.) "304.8 "	ANAP	AUTO
Imager Pixel Spacing	(0018,1164)	DS	Ex.) "0.160\0.160 "	ANAP	AUTO
Entrance Dose	(0040,0302)	US	Ex) 0	ANAP	AUTO
Entrance Dose in mGy	(0040,8302)	DS	Ex) "0 "	ANAP	AUTO

**Table 8.1-17
XA POSITIONER MODULE OF CREATED XA/RF IMAGE SOP INSTANCES**

Attribute Name	Tag	VR	Value	Presence of Value	Source
Distance Source to Detector	(0018,1110)	DS	Ex.) "1100"	ANAP	AUTO
Estimated Radiographic Magnification Factor	(0018,1114)	DS	Ex.) "1.2"	ANAP	AUTO
Positioner Motion	(0018,1500)	CS	Ex.) "STATIC"	ANAP	CONFIG

**Table 8.1-18
XRF POSITIONER MODULE OF CREATED XA/RF IMAGE SOP INSTANCES**

Attribute Name	Tag	VR	Value	Presence of Value	Source
Distance Source to Detector	(0018,1110)	DS	Ex.) "1100"	ANAP	AUTO
Estimated Radiographic Magnification Factor	(0018,1114)	DS	Ex.) "1.2"	ANAP	AUTO

**Table 8.1-19
VOI LUT MODULE OF CREATED XA/RF/SC IMAGE SOP INSTANCES**

Attribute Name	Tag	VR	Value	Presence of Value	Source
Window Center	(0028,1050)	DS	Ex.) "512 "	ALWAYS	AUTO
Window Width	(0028,1051)	DS	Ex.) "1023"	ALWAYS	AUTO

**Table 8.1-20
SC IMAGE MODULE OF CREATED SC IMAGE SOP INSTANCES**

Attribute Name	Tag	VR	Value	Presence of Value	Source
Date of Secondary Capture	(0018,1012)	UI	Ex.) "20090819"	ALWAYS	AUTO
Time of Secondary Capture	(0028,1014)	UI	Ex.) "183539"	ALWAYS	AUTO

**Table 8.1-21
X-RAY TABLE MODULE ATTRIBUTES**

Attribute Name	Tag	VR	Value	Presence of Value	Source
Table Motion	(0018,1134)	CS	"DYNAMIC"	ALWAYS	AUTO
Table Vertical Increment	(0018,1135)	DS	Ex.) "0"	VNAP	AUTO
Table Lateral Increment	(0018,1136)	DS	Ex.) "0"	VNAP	AUTO
Table Longitudinal Increment	(0018,1137)	DS	Ex.) "0"	VNAP	AUTO
Table Angle	(0018,1138)	DS	Ex.) "0"	VNAP	AUTO

8.1.1.7 DOSE SR Modules

Table 8.1-22
SR DOCUMENT SERIES MODULE ATTRIBETES

Attribute Name	Tag	VR	Value	Presence of Value	Source
Modality	(0008,0060)	CS	Ex.) "SR"	ALWAYS	AUTO
Series Instance UID	(0020,000E)	UI	Generated by device.	ALWAYS	AUTO
Series Number	(0020,0011)	IS	Ex.) "1 "	ALWAYS	AUTO
Referenced Performed Procedure Step Sequence	(0008,1111)	LO	Not Applicable	ALWAYS	AUTO

Table 8.1-23
ENHANCED GENERAL EQUIPMENT MODULE ATTRIBETES

Attribute Name	Tag	VR	Value	Presence of Value	Source
Manufacturer	(0008,0070)	LO	Ex.) "TOSHIBA "	ALWAYS	AUTO
Manufacturer's Model Name	(0008,1090)	LO	Ex.) "Platinum43 "	ALWAYS	AUTO
Device Serial Number	(0018,1000)	LO	From Configuration	ALWAYS	AUTO
Software Version	(0018,1020)	LO	Generated by device	ALWAYS	AUTO

Table 8.1-24
SR DOCUMENT GENERAL MODULES OF CREATED DOSE SR SOP INSTANCES

Attribute Name	Tag	VR	Value	Presence of Value	Source
Instance Number	(0020,0013)	IS	Ex.) "1 "	ALWAYS	AUTO
Content Date	(0008,0023)	DA	Ex.) "20150309"	ALWAYS	AUTO
Content Time	(0008,0033)	TM	Ex.) "111357"	ALWAYS	AUTO
Performed Procedure Code Sequence	(0040,A372)	SQ		ALWAYS	AUTO
Completion Flag	(0040,A491)	CS	Ex.) "PARTIAL "	ALWAYS	AUTO
Verification Flag	(0040,A493)	CS	Ex.) "UNVERIFIED"	ALWAYS	AUTO

Table 8.1-25
SR DOCUMENT CONTENT MODULES OF CREATED SR SOP INSTANCES

Attribute Name	Tag	VR	Value	Presence of Value	Source
Value Type	(0040,A040)	CS	Ex.) "CONTAINER "	ALWAYS	AUTO
Concept Name Code Sequence	(0040,A043)	SQ		ALWAYS	AUTO
>Code Value	(0008,0100)	SH	Ex.) "113701"	ALWAYS	AUTO
>Coding Scheme Designator	(0008,0102)	SH	Ex.) "DCM "	ALWAYS	AUTO
>Code Meaning	(0008,0104)	LO	Ex.) "X-Ray Radiation Dose Report "	ALWAYS	AUTO
Continuity Of Content	(0040,A050)	CS	Ex.) "SEPARATE"	ALWAYS	AUTO
Content Template Sequence	(0040,A504)	SQ		ALWAYS	AUTO
>Mapping Resource	(0008,0105)	CS	Ex.) "DCMR"	ALWAYS	AUTO
>Template Identifier	(0040,DB00)	CS	Ex.) "10001 "	ALWAYS	AUTO
Content Sequence	(0040,A730)	SQ		ALWAYS	AUTO
>Relationship Type	(0040,A010)	CS	Ex.) " HAS CONCEPT MOD"	ALWAYS	AUTO
>Value Type	(0040,A040)	CS	Ex.) "CODE"	ALWAYS	AUTO
>Concept Name Code Sequence	(0040,A043)	SQ		ALWAYS	AUTO
>>Code Value	(0008,0100)	SH	Ex.) "113704"	ALWAYS	AUTO
>>Coding Scheme Designator	(0008,0102)	SH	Ex.) "DCM "	ALWAYS	AUTO
>>Code Meaning	(0008,0104)	LO	Ex.) "Projection X-Ray"	ALWAYS	AUTO
>Content Sequence	(0040,A730)	SQ		ALWAYS	AUTO
>>Relationship Type	(0040,A010)	CS	Ex.) " HAS CONCEPT MOD"	ALWAYS	AUTO
>>Value Type	(0040,A040)	CS	Ex.) "CODE"	ALWAYS	AUTO
>>Concept Name Code Sequence	(0040,A043)	SQ		ALWAYS	AUTO
>>>Code Value	(0008,0100)	SH	Ex.) "G-C0E8"	ALWAYS	AUTO
>>>Coding Scheme Designator	(0008,0102)	SH	Ex.) "SRT"	ALWAYS	AUTO
>>>Code Meaning	(0008,0104)	LO	Ex.) "Has Intent"	ALWAYS	AUTO
>>Concept Code Sequence	(0040,A168)	SQ		ALWAYS	AUTO
>>>Code Value	(0008,0100)	SH	Ex.) "R-408C3"	ALWAYS	AUTO
>>>Coding Scheme Designator	(0008,0102)	SH	Ex.) "SRT"	ALWAYS	AUTO
>>>Code Meaning	(0008,0104)	LO	Ex.) " Diagnostic Intent"	ALWAYS	AUTO
>Relationship Type	(0040,A010)	CS	Ex.) " HAS OBS CONTEXT"	ALWAYS	AUTO

>Value Type	(0040,A040)	CS	Ex.) "CODE"	ALWAYS	AUTO
>Concept Name Code Sequence	(0040,A043)	SQ		ALWAYS	AUTO
>>Code Value	(0008,0100)	SH	Ex.) "121005"	ALWAYS	AUTO
>>Coding Scheme Designator	(0008,0102)	SH	Ex.) "SRT"	ALWAYS	AUTO
>>Code Meaning	(0008,0104)	LO	Ex.) "Observer Type"	ALWAYS	AUTO
>Concept Code Sequence	(0040,A168)	SQ		ALWAYS	AUTO
>>Code Value	(0008,0100)	SH	Ex.) "121007"	ALWAYS	AUTO
>>Coding Scheme Designator	(0008,0102)	SH	Ex.) "DCM"	ALWAYS	AUTO
>>Code Meaning	(0008,0104)	LO	Ex.) " Device"	ALWAYS	AUTO
>Relationship Type	(0040,A010)	CS	Ex.) " HAS OBS CONTEXT"	ALWAYS	AUTO
>Value Type	(0040,A040)	CS	Ex.) "UIDREF"	ALWAYS	AUTO
>Concept Name Code Sequence	(0040,A043)	SQ		ALWAYS	AUTO
>>Code Value	(0008,0100)	SH	Ex.) "121012"	ALWAYS	AUTO
>>Coding Scheme Designator	(0008,0102)	SH	Ex.) "DCM"	ALWAYS	AUTO
>>Code Meaning	(0008,0104)	LO	Ex.) "Device Observer UID"	ALWAYS	AUTO
>UID	(0040,A124)	UI	Ex.) "2.16.840.1.113669.632.3.1902522603"	ALWAYS	AUTO
>Relationship Type	(0040,A010)	CS	Ex.) " HAS OBS CONTEXT"	ALWAYS	AUTO
>Value Type	(0040,A040)	CS	Ex.) "TEXT"	ALWAYS	AUTO
>Concept Name Code Sequence	(0040,A043)	SQ		ALWAYS	AUTO
>>Code Value	(0008,0100)	SH	Ex.) "121014"	ALWAYS	AUTO
>>Coding Scheme Designator	(0008,0102)	SH	Ex.) "DCM"	ALWAYS	AUTO
>>Code Meaning	(0008,0104)	LO	Ex.) "Device Observer Manufacturer"	ALWAYS	AUTO
>Text Value	(0040,A160)	UT	Ex.) "Toshiba"	ALWAYS	AUTO
>Relationship Type	(0040,A010)	CS	Ex.) "HAS OBS CONTEXT"	ALWAYS	AUTO
>Value Type	(0040,A040)	CS	Ex.) "TEXT"	ALWAYS	AUTO
>Concept Name Code Sequence	(0040,A043)	SQ		ALWAYS	AUTO
>>Code Value	(0008,0100)	SH	Ex.) "121015"	ALWAYS	AUTO
>>Coding Scheme Designator	(0008,0102)	SH	Ex.) "DCM"	ALWAYS	AUTO
>>Code Meaning	(0008,0104)	LO	Ex.) "Device Observer Model Name"	ALWAYS	AUTO
>Text Value	(0040,A160)	UT	Ex.) "Platinum43"	ALWAYS	AUTO
>Relationship Type	(0040,A010)	CS	Ex.) " HAS OBS CONTEXT"	ALWAYS	AUTO
>Value Type	(0040,A040)	CS	Ex.) "TEXT"	ALWAYS	AUTO
>Concept Name Code Sequence	(0040,A043)	SQ		ALWAYS	AUTO
>>Code Value	(0008,0100)	SH	Ex.) "121016"	ALWAYS	AUTO

>>Coding Scheme Designator	(0008,0102)	SH	Ex.) "DCM"	ALWAYS	AUTO
>>Code Meaning	(0008,0104)	LO	Ex.) "Device Observer Serial Number"	ALWAYS	AUTO
>Text Value	(0040,A160)	UT	Same as (0018,1000) Device Serial Number	ALWAYS	AUTO
>Relationship Type	(0040,A010)	CS	Ex.) " HAS OBS CONTEXT"	ALWAYS	AUTO
>Value Type	(0040,A040)	CS	Ex.) "CODE"	ALWAYS	AUTO
>Concept Name Code Sequence	(0040,A043)	SQ		ALWAYS	AUTO
>>Code Value	(0008,0100)	SH	Ex.) "113705"	ALWAYS	AUTO
>>Coding Scheme Designator	(0008,0102)	SH	Ex.) "DCM"	ALWAYS	AUTO
>>Code Meaning	(0008,0104)	LO	Ex.) "Scope of Accumulation"	ALWAYS	AUTO
>Text Value	(0040,A160)	UT	Ex.) "Platinum43"	ALWAYS	AUTO
>Concept Code Sequence	(0040,A168)	SQ		ALWAYS	AUTO
>>Code Value	(0008,0100)	SH	Ex.) "113016"	ALWAYS	AUTO
>>Coding Scheme Designator	(0008,0102)	SH	Ex.) "DCM"	ALWAYS	AUTO
>>Code Meaning	(0008,0104)	LO	Ex.) "Performed Procedure Step"	ALWAYS	AUTO
>Content Sequence	(0040,A730)	SQ		ALWAYS	AUTO
>>Relationship Type	(0040,A010)	CS	Ex.) "HAS PROPERTIES"	ALWAYS	AUTO
>>Value Type	(0040,A040)	CS	Ex.) "UIDREF"	ALWAYS	AUTO
>>Concept Name Code Sequence	(0040,A043)	SQ		ALWAYS	AUTO
>>>Code Value	(0008,0100)	SH	Ex.) "110180"	ALWAYS	AUTO
>>>Coding Scheme Designator	(0008,0102)	SH	Ex.) "DCM"	ALWAYS	AUTO
>>>Code Meaning	(0008,0104)	LO	Ex.) "Study Instance UID"	ALWAYS	AUTO
>>UID	(0040,A124)	UI	Same as (0020,000D) Study Instance UID	ALWAYS	AUTO
>Relationship Type	(0040,A010)	CS	Ex.) "CONTAINS"	ALWAYS	AUTO
>Value Type	(0040,A040)	CS	Ex.) "CONTAINER "	ALWAYS	AUTO
>Concept Name Code Sequence	(0040,A043)	SQ		ALWAYS	AUTO
>>Code Value	(0008,0100)	SH	Ex.) "113702"	ALWAYS	AUTO
>>Coding Scheme Designator	(0008,0102)	SH	Ex.) "DCM "	ALWAYS	AUTO
>>Code Meaning	(0008,0104)	LO	Ex.) "Accumulated X-Ray Dose Data"	ALWAYS	AUTO
>Continuity Of Content	(0040,A050)	CS	Ex.) "CONTINUOUS"	ALWAYS	AUTO
>Content Template Sequence	(0040,A504)	SQ		ALWAYS	AUTO
>>Mapping Resource	(0008,0105)	CS	Ex.) "DCMR"	ALWAYS	AUTO

>>Template Identifier	(0040,DB00)	CS	Ex.) "10002"	ALWAYS	AUTO
>>Relationship Type	(0040,A010)	CS	Ex.) "HAS CONCEPT MOD"	ALWAYS	AUTO
>>Value Type	(0040,A040)	CS	Ex.) "CODE"	ALWAYS	AUTO
>>Concept Name Code Sequence	(0040,A043)	SQ		ALWAYS	AUTO
>>>Code Value	(0008,0100)	SH	Ex.) "113764"	ALWAYS	AUTO
>>>Coding Scheme Designator	(0008,0102)	SH	Ex.) "DCM"	ALWAYS	AUTO
>>>Code Meaning	(0008,0104)	LO	Ex.) "Acquisition Plane"	ALWAYS	AUTO
>>Concept Code Sequence	(0040,A168)	SQ		ALWAYS	AUTO
>>>Code Value	(0008,0100)	SH	Ex.) "113622"	ALWAYS	AUTO
>>>Coding Scheme Designator	(0008,0102)	SH	Ex.) "DCM"	ALWAYS	AUTO
>>>Code Meaning	(0008,0104)	LO	Ex.) "Single Plane"	ALWAYS	AUTO
>>Relationship Type	(0040,A010)	CS	Ex.) "CONTAINS"	ALWAYS	AUTO
>>Value Type	(0040,A040)	CS	Ex.) "NUM"	ALWAYS	AUTO
>>Concept Name Code Sequence	(0040,A043)	SQ		ALWAYS	AUTO
>>>Code Value	(0008,0100)	SH	Ex.) "113722"	ALWAYS	AUTO
>>>Coding Scheme Designator	(0008,0102)	SH	Ex.) "DCM"	ALWAYS	AUTO
>>>Code Meaning	(0008,0104)	LO	Ex.) "Dose Area Product Total"	ALWAYS	AUTO
>>Measured Value Sequence	(0040,A300)	SQ		ALWAYS	AUTO
>>>Measurement Units Code Sequence	(0040,08EA)	SQ		ALWAYS	AUTO
>>>>Code Value	(0008,0100)	SH	Ex.) "dGy.cm2"	ALWAYS	AUTO
>>>>Coding Scheme Designator	(0008,0102)	SH	Ex.) "UCUM"	ALWAYS	AUTO
>>>>Code Meaning	(0008,0104)	LO	Ex.) "dGy.cm2"	ALWAYS	AUTO
>>>Numeric Value	(0040,A30A)	DS	Ex.) "5.185"	ALWAYS	AUTO
>>Relationship Type	(0040,A010)	CS	Ex.) "CONTAINS"	ALWAYS	AUTO
>>Value Type	(0040,A040)	CS	Ex.) "NUM "	ALWAYS	AUTO
>>Concept Name Code Sequence	(0040,A043)	SQ		ALWAYS	AUTO
>>>Code Value	(0008,0100)	SH	Ex.) "113725"	ALWAYS	AUTO
>>>Coding Scheme Designator	(0008,0102)	SH	Ex.) "DCM "	ALWAYS	AUTO

>>>Code Meaning	(0008,0104)	LO	Ex.) "Dose (RP) Total "	ALWAYS	AUTO
>>Measured Value Sequence	(0040,A300)	SQ		ALWAYS	AUTO
>>>Measurement Units Code Sequence	(0040,08EA)	SQ		ALWAYS	AUTO
>>>>Code Value	(0008,0100)	SH	Ex.) "mGy "	ALWAYS	AUTO
>>>>Coding Scheme Designator	(0008,0102)	SH	Ex.) "UCUM"	ALWAYS	AUTO
>>>>Code Meaning	(0008,0104)	LO	Ex.) "mGy "	ALWAYS	AUTO
>>>Numeric Value	(0040,A30A)	DS	Ex.) "0.448"	ALWAYS	AUTO
>>Relationship Type	(0040,A010)	CS	Ex.) "CONTAINS"	ANAP	AUTO
>>Value Type	(0040,A040)	CS	Ex.) "NUM "	ANAP	AUTO
>>Concept Name Code Sequence	(0040,A043)	SQ		ANAP	AUTO
>>>Code Value	(0008,0100)	SH	Ex.) "113726"	ALWAYS	AUTO
>>>Coding Scheme Designator	(0008,0102)	SH	Ex.) "DCM "	ALWAYS	AUTO
>>>Code Meaning	(0008,0104)	LO	Ex.) "Fluoro Dose Area Product Total "	ALWAYS	AUTO
>>Measured Value Sequence	(0040,A300)	SQ		ANAP	AUTO
>>>Measurement Units Code Sequence	(0040,08EA)	SQ		ALWAYS	AUTO
>>>>Code Value	(0008,0100)	SH	Ex.) "dGy.cm2"	ALWAYS	AUTO
>>>>Coding Scheme Designator	(0008,0102)	SH	Ex.) "UCUM"	ALWAYS	AUTO
>>>>Code Meaning	(0008,0104)	LO	Ex.) "dGy.cm2"	ALWAYS	AUTO
>>>Numeric Value	(0040,A30A)	DS	Ex.) "4.580"	ALWAYS	AUTO
>>Relationship Type	(0040,A010)	CS	Ex.) "CONTAINS"	ANAP	AUTO
>>Value Type	(0040,A040)	CS	Ex.) "NUM "	ANAP	AUTO
>>Concept Name Code Sequence	(0040,A043)	SQ		ANAP	AUTO
>>>Code Value	(0008,0100)	SH	Ex.) "113728"	ALWAYS	AUTO
>>>Coding Scheme Designator	(0008,0102)	SH	Ex.) "DCM "	ALWAYS	AUTO
>>>Code Meaning	(0008,0104)	LO	Ex.) "Fluoro Dose (RP) Total "	ALWAYS	AUTO
>>Measured Value Sequence	(0040,A300)	SQ		ANAP	AUTO
>>>Measurement Units Code Sequence	(0040,08EA)	SQ		ALWAYS	AUTO

>>>>Code Value	(0008,0100)	SH	Ex.) "mGy "	ALWAYS	AUTO
>>>>Coding Scheme Designator	(0008,0102)	SH	Ex.) "UCUM"	ALWAYS	AUTO
>>>>Code Meaning	(0008,0104)	LO	Ex.) "mGy "	ALWAYS	AUTO
>>>Numeric Value	(0040,A30A)	DS	Ex.) "0.394"	ALWAYS	AUTO
>>Relationship Type	(0040,A010)	CS	Ex.) "CONTAINS"	ANAP	AUTO
>>Value Type	(0040,A040)	CS	Ex.) "NUM "	ANAP	AUTO
>>Concept Name Code Sequence	(0040,A043)	SQ		ANAP	AUTO
>>>Code Value	(0008,0100)	SH	Ex.) "113730"	ALWAYS	AUTO
>>>Coding Scheme Designator	(0008,0102)	SH	Ex.) "DCM "	ALWAYS	AUTO
>>>Code Meaning	(0008,0104)	LO	Ex.) "Total Fluoro Time"	ALWAYS	AUTO
>>Measured Value Sequence	(0040,A300)	SQ		ANAP	AUTO
>>>Measurement Units Code Sequence	(0040,08EA)	SQ		ALWAYS	AUTO
>>>>Code Value	(0008,0100)	SH	Ex.) "s "	ALWAYS	AUTO
>>>>Coding Scheme Designator	(0008,0102)	SH	Ex.) "UCUM"	ALWAYS	AUTO
>>>>Code Meaning	(0008,0104)	LO	Ex.) "s "	ALWAYS	AUTO
>>>Numeric Value	(0040,A30A)	DS	Ex.) "17.000000"	ALWAYS	AUTO
>>Relationship Type	(0040,A010)	CS	Ex.) "CONTAINS"	ALWAYS	AUTO
>>Value Type	(0040,A040)	CS	Ex.) "NUM "	ALWAYS	AUTO
>>Concept Name Code Sequence	(0040,A043)	SQ		ALWAYS	AUTO
>>>Code Value	(0008,0100)	SH	Ex.) "113727"	ALWAYS	AUTO
>>>Coding Scheme Designator	(0008,0102)	SH	Ex.) "DCM "	ALWAYS	AUTO
>>>Code Meaning	(0008,0104)	LO	Ex.) "Acquisition Dose Area Product Total "	ALWAYS	AUTO
>>Measured Value Sequence	(0040,A300)	SQ		ALWAYS	AUTO
>>>Measurement Units Code Sequence	(0040,08EA)	SQ		ALWAYS	AUTO
>>>>Code Value	(0008,0100)	SH	Ex.)"dGy.cm2"	ALWAYS	AUTO
>>>>Coding Scheme Designator	(0008,0102)	SH	Ex.)"UCUM"	ALWAYS	AUTO

>>>>Code Meaning	(0008,0104)	LO	Ex.)"dGy.cm2"	ALWAYS	AUTO
>>>Numeric Value	(0040,A30A)	DS	Ex.)"0.605"	ALWAYS	AUTO
>>Relationship Type	(0040,A010)	CS	Ex.) "CONTAINS"	ALWAYS	AUTO
>>Value Type	(0040,A040)	CS	Ex.) "NUM "	ALWAYS	AUTO
>>Concept Name Code Sequence	(0040,A043)	SQ		ALWAYS	AUTO
>>>Code Value	(0008,0100)	SH	Ex.) "113729"	ALWAYS	AUTO
>>>Coding Scheme Designator	(0008,0102)	SH	Ex.) "DCM "	ALWAYS	AUTO
>>>Code Meaning	(0008,0104)	LO	Ex.) "Acquisition Dose (RP) Total"	ALWAYS	AUTO
>>Measured Value Sequence	(0040,A300)	SQ		ALWAYS	AUTO
>>>Measurement Units Code Sequence	(0040,08EA)	SQ		ALWAYS	AUTO
>>>>Code Value	(0008,0100)	SH	Ex.) "mGy"	ALWAYS	AUTO
>>>>Coding Scheme Designator	(0008,0102)	SH	Ex.) "UCUM"	ALWAYS	AUTO
>>>>Code Meaning	(0008,0104)	LO	Ex.) "mGy"	ALWAYS	AUTO
>>>Numeric Value	(0040,A30A)	DS	Ex.) "0.054"	ALWAYS	AUTO
>>Relationship Type	(0040,A010)	CS	Ex.) "CONTAINS"	ALWAYS	AUTO
>>Value Type	(0040,A040)	CS	Ex.) "NUM "	ALWAYS	AUTO
>>Concept Name Code Sequence	(0040,A043)	SQ		ALWAYS	AUTO
>>>Code Value	(0008,0100)	SH	Ex.) "113855"	ALWAYS	AUTO
>>>Coding Scheme Designator	(0008,0102)	SH	Ex.) "DCM "	ALWAYS	AUTO
>>>Code Meaning	(0008,0104)	LO	Ex.) "Total Acquisition Time"	ALWAYS	AUTO
>>Measured Value Sequence	(0040,A300)	SQ		ALWAYS	AUTO
>>>Measurement Units Code Sequence	(0040,08EA)	SQ		ALWAYS	AUTO
>>>>Code Value	(0008,0100)	SH	Ex.) "s "	ALWAYS	AUTO
>>>>Coding Scheme Designator	(0008,0102)	SH	Ex.) "UCUM"	ALWAYS	AUTO
>>>>Code Meaning	(0008,0104)	LO	Ex.) "s "	ALWAYS	AUTO
>>>Numeric Value	(0040,A30A)	DS	Ex.) "0.500000"	ALWAYS	AUTO
>>Relationship Type	(0040,A010)	CS	Ex.) "CONTAINS"	ALWAYS	AUTO
>>Value Type	(0040,A040)	CS	Ex.) "TEXT "	ALWAYS	AUTO

>>>Code Value	(0008,0100)	SH	Ex.) "113780"	ALWAYS	AUTO
>>>Coding Scheme Designator	(0008,0102)	SH	Ex.) "DCM "	ALWAYS	AUTO
>>>Code Meaning	(0008,0104)	LO	Ex.) "Reference Point Definition"	ALWAYS	AUTO
>>Text Value	(0040,A160)	UT	Ex.) "48.0 cm Chamber Patient Distance"	ALWAYS	CONFIG
>Relationship Type	(0040,A010)	CS	Ex.) "CONTAINS"	ALWAYS	AUTO
>Value Type	(0040,A040)	CS	Ex.) "CONTAINER "	ALWAYS	AUTO
>Concept Name Code Sequence	(0040,A043)	SQ		ALWAYS	AUTO
>>Code Value	(0008,0100)	SH	Ex.) "113706"	ALWAYS	AUTO
>>Coding Scheme Designator	(0008,0102)	SH	Ex.) "DCM "	ALWAYS	AUTO
>>Code Meaning	(0008,0104)	LO	Ex.) "Irradiation Event X-Ray Data"	ALWAYS	AUTO
>Continuity Of Content	(0040,A050)	CS	Ex.)"SEPARATE"	ALWAYS	AUTO
>Content Template Sequence	(0040,A504)	SQ		ALWAYS	AUTO
>>Mapping Resource	(0008,0105)	CS	Ex.)"DCMR"	ALWAYS	AUTO
>>Template Identifier	(0040,DB00)	CS	Ex.)"10003 "	ALWAYS	AUTO
>Content Sequence	(0040,A730)	SQ		ALWAYS	AUTO
>>Relationship Type	(0040,A010)	CS	Ex.) "HAS CONCEPT MOD"	ALWAYS	AUTO
>>Value Type	(0040,A040)	CS	Ex.) "CODE"	ALWAYS	AUTO
>>Concept Name Code Sequence	(0040,A043)	SQ		ALWAYS	AUTO
>>>Code Value	(0008,0100)	SH	Ex.) "113764"	ALWAYS	AUTO
>>>Coding Scheme Designator	(0008,0102)	SH	Ex.) "DCM "	ALWAYS	AUTO
>>>Code Meaning	(0008,0104)	LO	Ex.) "Acquisition Plane"	ALWAYS	AUTO
>>Concept Code Sequence	(0040,A168)	SQ		ALWAYS	AUTO
>>>Code Value	(0008,0100)	SH	Ex.) "113622"	ALWAYS	AUTO
>>>Coding Scheme Designator	(0008,0102)	SH	Ex.) "DCM"	ALWAYS	AUTO
>>>Code Meaning	(0008,0104)	LO	Ex.) "Single Plane"	ALWAYS	AUTO
>>Relationship Type	(0040,A010)	CS	Ex.) "CONTAINS"	ALWAYS	AUTO
>>Value Type	(0040,A040)	CS	Ex.) "DATETIME "	ALWAYS	AUTO
>>Concept Name Code Sequence	(0040,A043)	SQ		ALWAYS	AUTO
>>>Code Value	(0008,0100)	SH	Ex.) "111526"	ALWAYS	AUTO

>>>Coding Scheme Designator	(0008,0102)	SH	Ex.) "DCM "	ALWAYS	AUTO
>>>Code Meaning	(0008,0104)	LO	Ex.) "DateTime Started"	ALWAYS	AUTO
>>Date Time	(0040,A120)	DT	Ex.) "20150309111413"	ALWAYS	AUTO
>>Relationship Type	(0040,A010)	CS	Ex.) "CONTAINS"	ALWAYS	AUTO
>>Value Type	(0040,A040)	CS	Ex.) "CODE"	ALWAYS	AUTO
>>Concept Name Code Sequence	(0040,A043)	SQ		ALWAYS	AUTO
>>>Code Value	(0008,0100)	SH	Ex.) "113721"	ALWAYS	AUTO
>>>Coding Scheme Designator	(0008,0102)	SH	Ex.) "DCM "	ALWAYS	AUTO
>>>Code Meaning	(0008,0104)	LO	Ex.) "Irradiation Event Type"	ALWAYS	AUTO
>>Concept Code Sequence	(0040,A168)	SQ		ALWAYS	AUTO
>>>Code Value	(0008,0100)	SH	Ex.) "P5-06000"	ALWAYS	AUTO
>>>Coding Scheme Designator	(0008,0102)	SH	Ex.) "SRT "	ALWAYS	AUTO
>>>Code Meaning	(0008,0104)	LO	Ex.) "Fluoroscopy "	ALWAYS	AUTO
>>Relationship Type	(0040,A010)	CS	Ex.) "CONTAINS"	ALWAYS	AUTO
>>Value Type	(0040,A040)	CS	Ex.) "TEXT"	ALWAYS	AUTO
>>Concept Name Code Sequence	(0040,A043)	SQ		ALWAYS	AUTO
>>>Code Value	(0008,0100)	SH	Ex.) "125203"	ALWAYS	AUTO
>>>Coding Scheme Designator	(0008,0102)	SH	Ex.) "DCM "	ALWAYS	AUTO
>>>Code Meaning	(0008,0104)	LO	Ex.) "Acquisition Protocol"	ALWAYS	AUTO
>>Text Value	(0040,A160)	UT	Ex.) "DR"	ALWAYS	AUTO
>>Relationship Type	(0040,A010)	CS	Ex.) "CONTAINS"	ALWAYS	AUTO
>>Value Type	(0040,A040)	CS	Ex.) "TEXT "	ALWAYS	AUTO
>>>Code Value	(0008,0100)	SH	Ex.) "113780"	ALWAYS	AUTO
>>>Coding Scheme Designator	(0008,0102)	SH	Ex.) "DCM "	ALWAYS	AUTO
>>>Code Meaning	(0008,0104)	LO	Ex.) "Reference Point Definition"	ALWAYS	AUTO
>>Text Value	(0040,A160)	UT	Ex.) "48.0 cm Chamber Patient Distance"	ALWAYS	CONFIG
>>Relationship Type	(0040,A010)	CS	Ex.) "CONTAINS"	ALWAYS	AUTO
>>Value Type	(0040,A040)	CS	Ex.) "UIDREF"	ALWAYS	AUTO
>>>Code Value	(0008,0100)	SH	Ex.) "113769"	ALWAYS	AUTO

>>>Coding Scheme Designator	(0008,0102)	SH	Ex.) "DCM "	ALWAYS	AUTO
>>>Code Meaning	(0008,0104)	LO	Ex.) "Irradiation Event UID"	ALWAYS	AUTO
>>UID	(0040,A124)	UI	Ex.) "2.16.840.1.113669.632.3.4218044518 125754352829984672022103385265"	ALWAYS	AUTO
>>Relationship Type	(0040,A010)	CS	Ex.) "CONTAINS"	ALWAYS	AUTO
>>Value Type	(0040,A040)	CS	Ex.) "NUM "	ALWAYS	AUTO
>>Concept Name Code Sequence	(0040,A043)	SQ		ALWAYS	AUTO
>>>Code Value	(0008,0100)	SH	Ex.) "122130"	ALWAYS	AUTO
>>>Coding Scheme Designator	(0008,0102)	SH	Ex.) "DCM "	ALWAYS	AUTO
>>>Code Meaning	(0008,0104)	LO	Ex.) "Dose Area Product "	ALWAYS	AUTO
>>Measured Value Sequence	(0040,A300)	SQ		ALWAYS	AUTO
>>>Measurement Units Code Sequence	(0040,08EA)	SQ		ALWAYS	AUTO
>>>>Code Value	(0008,0100)	SH	Ex.) "dGy.cm2"	ALWAYS	AUTO
>>>>Coding Scheme Designator	(0008,0102)	SH	Ex.) "UCUM"	ALWAYS	AUTO
>>>>Code Meaning	(0008,0104)	LO	Ex.) "dGy.cm2"	ALWAYS	AUTO
>>>Numeric Value	(0040,A30A)	DS	Ex.) "0.334"	ALWAYS	AUTO
>>Relationship Type	(0040,A010)	CS	Ex.) "CONTAINS"	ALWAYS	AUTO
>>Value Type	(0040,A040)	CS	Ex.) "NUM "	ALWAYS	AUTO
>>Concept Name Code Sequence	(0040,A043)	SQ		ALWAYS	AUTO
>>>Code Value	(0008,0100)	SH	Ex.) "113738"	ALWAYS	AUTO
>>>Coding Scheme Designator	(0008,0102)	SH	Ex.) "DCM"	ALWAYS	AUTO
>>>Code Meaning	(0008,0104)	LO	Ex.) "Dose (RP)"	ALWAYS	AUTO
>>Measured Value Sequence	(0040,A300)	SQ		ALWAYS	AUTO
>>>Measurement Units Code Sequence	(0040,08EA)	SQ		ALWAYS	AUTO
>>>>Code Value	(0008,0100)	SH	Ex.) "mGy"	ALWAYS	AUTO
>>>>Coding Scheme Designator	(0008,0102)	SH	Ex.) "UCUM"	ALWAYS	AUTO
>>>>Code Meaning	(0008,0104)	LO	Ex.) "mGy"	ALWAYS	AUTO

>>>Numeric Value	(0040,A30A)	DS	Ex.) "0.030"	ALWAYS	AUTO
>>Relationship Type	(0040,A010)	CS	Ex.) "CONTAINS"	ANAP	AUTO
>>Value Type	(0040,A040)	CS	Ex.) "CODE"	ANAP	AUTO
>>Concept Name Code Sequence	(0040,A043)	SQ		ANAP	AUTO
>>>Code Value	(0008,0100)	SH	Ex.) "113732"	ALWAYS	AUTO
>>>Coding Scheme Designator	(0008,0102)	SH	Ex.) "DCM"	ALWAYS	AUTO
>>>Code Meaning	(0008,0104)	LO	Ex.) "Fluoro Mode"	ALWAYS	AUTO
>>Concept Code Sequence	(0040,A168)	SQ		ANAP	AUTO
>>>Code Value	(0008,0100)	SH	Ex.) "113630"	ALWAYS	AUTO
>>>Coding Scheme Designator	(0008,0102)	SH	Ex.) "DCM"	ALWAYS	AUTO
>>>Code Meaning	(0008,0104)	LO	Ex.) "Continuous"	ALWAYS	AUTO
>>Relationship Type	(0040,A010)	CS	Ex.) "CONTAINS"	ANAP	AUTO
>>Value Type	(0040,A040)	CS	Ex.) "NUM "	ANAP	AUTO
>>Concept Name Code Sequence	(0040,A043)	SQ		ANAP	AUTO
>>>Code Value	(0008,0100)	SH	Ex.) "113791"	ALWAYS	AUTO
>>>Coding Scheme Designator	(0008,0102)	SH	Ex.) "DCM"	ALWAYS	AUTO
>>>Code Meaning	(0008,0104)	LO	Ex.) "Pulse Rate"	ALWAYS	AUTO
>>Measured Value Sequence	(0040,A300)	SQ		ANAP	AUTO
>>>Measurement Units Code Sequence	(0040,08EA)	SQ		ALWAYS	AUTO
>>>>Code Value	(0008,0100)	SH	Ex.) "{pulse}/s"	ALWAYS	AUTO
>>>>Coding Scheme Designator	(0008,0102)	SH	Ex.)"UCUM"	ALWAYS	AUTO
>>>>Code Meaning	(0008,0104)	LO	Ex.) "pulse/s"	ALWAYS	AUTO
>>>Numeric Value	(0040,A30A)	DS	Ex.) "15.000000"	ALWAYS	AUTO
>>Relationship Type	(0040,A010)	CS	Ex.) "CONTAINS"	ANAP	AUTO
>>Value Type	(0040,A040)	CS	Ex.) "NUM "	ANAP	AUTO
>>Concept Name Code Sequence	(0040,A043)	SQ		ANAP	AUTO
>>>Code Value	(0008,0100)	SH	Ex.) "113768"	ALWAYS	AUTO
>>>Coding Scheme Designator	(0008,0102)	SH	Ex.) "DCM"	ALWAYS	AUTO

>>>Code Meaning	(0008,0104)	LO	Ex.) "Number of Pulses"	ALWAYS	AUTO
>>Measured Value Sequence	(0040,A300)	SQ		ANAP	AUTO
>>>Measurement Units Code Sequence	(0040,08EA)	SQ		ALWAYS	AUTO
>>>>Code Value	(0008,0100)	SH	Ex.) "1"	ALWAYS	AUTO
>>>>Coding Scheme Designator	(0008,0102)	SH	Ex.)"UCUM"	ALWAYS	AUTO
>>>>Code Meaning	(0008,0104)	LO	Ex.) "no units"	ALWAYS	AUTO
>>>Numeric Value	(0040,A30A)	DS	Ex.) "91"	ALWAYS	AUTO
>>Relationship Type	(0040,A010)	CS	Ex.) "CONTAINS"	ALWAYS	AUTO
>>Value Type	(0040,A040)	CS	Ex.) "NUM"	ALWAYS	AUTO
>>Concept Name Code Sequence	(0040,A043)	SQ		ALWAYS	AUTO
>>>Code Value	(0008,0100)	SH	Ex.) "113733"	ALWAYS	AUTO
>>>Coding Scheme Designator	(0008,0102)	SH	Ex.) "DCM"	ALWAYS	AUTO
>>>Code Meaning	(0008,0104)	LO	Ex.) "KVP"	ALWAYS	AUTO
>>Measured Value Sequence	(0040,A300)	SQ		ALWAYS	AUTO
>>>Measurement Units Code Sequence	(0040,08EA)	SQ		ALWAYS	AUTO
>>>>Code Value	(0008,0100)	SH	Ex.) "kV"	ALWAYS	AUTO
>>>>Coding Scheme Designator	(0008,0102)	SH	Ex.)"UCUM"	ALWAYS	AUTO
>>>>Code Meaning	(0008,0104)	LO	Ex.) "kV"	ALWAYS	AUTO
>>>Numeric Value	(0040,A30A)	DS	Ex.) "65.000000"	ALWAYS	AUTO
>>Relationship Type	(0040,A010)	CS	Ex.) "CONTAINS"	ALWAYS	AUTO
>>Value Type	(0040,A040)	CS	Ex.) "NUM "	ALWAYS	AUTO
>>Concept Name Code Sequence	(0040,A043)	SQ		ALWAYS	AUTO
>>>Code Value	(0008,0100)	SH	Ex.) "113734"	ALWAYS	AUTO
>>>Coding Scheme Designator	(0008,0102)	SH	Ex.) "DCM "	ALWAYS	AUTO
>>>Code Meaning	(0008,0104)	LO	Ex.) "X-Ray Tube Current"	ALWAYS	AUTO
>>Measured Value Sequence	(0040,A300)	SQ		ALWAYS	AUTO
>>>Measurement Units Code Sequence	(0040,08EA)	SQ		ALWAYS	AUTO

>>>>Code Value	(0008,0100)	SH	Ex.) "mA"	ALWAYS	AUTO
>>>>Coding Scheme Designator	(0008,0102)	SH	Ex.) "UCUM"	ALWAYS	AUTO
>>>>Code Meaning	(0008,0104)	LO	Ex.) "mA"	ALWAYS	AUTO
>>>Numeric Value	(0040,A30A)	DS	Ex.) "0.800000 "	ALWAYS	AUTO
>>Relationship Type	(0040,A010)	CS	Ex.) "CONTAINS"	ALWAYS	AUTO
>>Value Type	(0040,A040)	CS	Ex.) "NUM "	ALWAYS	AUTO
>>Concept Name Code Sequence	(0040,A043)	SQ		ALWAYS	AUTO
>>>>Code Value	(0008,0100)	SH	Ex.) "113735"	ALWAYS	AUTO
>>>>Coding Scheme Designator	(0008,0102)	SH	Ex.) "DCM "	ALWAYS	AUTO
>>>>Code Meaning	(0008,0104)	LO	Ex.) "Exposure Time "	ALWAYS	AUTO
>>Measured Value Sequence	(0040,A300)	SQ		ALWAYS	AUTO
>>>>Measurement Units Code Sequence	(0040,08EA)	SQ		ALWAYS	AUTO
>>>>Code Value	(0008,0100)	SH	Ex.) "ms"	ALWAYS	AUTO
>>>>Coding Scheme Designator	(0008,0102)	SH	Ex.) "UCUM"	ALWAYS	AUTO
>>>>Code Meaning	(0008,0104)	LO	Ex.) "ms"	ALWAYS	AUTO
>>>Numeric Value	(0040,A30A)	DS	Ex.) "2000.000000 "	ALWAYS	AUTO
>>Relationship Type	(0040,A010)	CS	Ex.) "CONTAINS"	ALWAYS	AUTO
>>Value Type	(0040,A040)	CS	Ex.) "NUM "	ALWAYS	AUTO
>>Concept Name Code Sequence	(0040,A043)	SQ		ALWAYS	AUTO
>>>>Code Value	(0008,0100)	SH	Ex.) "113793"	ALWAYS	AUTO
>>>>Coding Scheme Designator	(0008,0102)	SH	Ex.) "DCM "	ALWAYS	AUTO
>>>>Code Meaning	(0008,0104)	LO	Ex.) "Pulse Width "	ALWAYS	AUTO
>>Measured Value Sequence	(0040,A300)	SQ		ALWAYS	AUTO
>>>>Measurement Units Code Sequence	(0040,08EA)	SQ		ALWAYS	AUTO
>>>>Code Value	(0008,0100)	SH	Ex.) "ms"	ALWAYS	AUTO
>>>>Coding Scheme Designator	(0008,0102)	SH	Ex.) "UCUM"	ALWAYS	AUTO
>>>>Code Meaning	(0008,0104)	LO	Ex.) "ms"	ALWAYS	AUTO

>>>Numeric Value	(0040,A30A)	DS	Ex.) "0 "	ALWAYS	AUTO
>>Relationship Type	(0040,A010)	CS	Ex.)"CONTAINS"	ALWAYS	AUTO
>>Value Type	(0040,A040)	CS	Ex.)"NUM "	ALWAYS	AUTO
>>Concept Name Code Sequence	(0040,A043)	SQ		ALWAYS	AUTO
>>>Code Value	(0008,0100)	SH	Ex.) "113742"	ALWAYS	AUTO
>>>Coding Scheme Designator	(0008,0102)	SH	Ex.) "DCM "	ALWAYS	AUTO
>>>Code Meaning	(0008,0104)	LO	Ex.) "Irradiation Duration"	ALWAYS	AUTO
>>Measured Value Sequence	(0040,A300)	SQ		ALWAYS	AUTO
>>>Measurement Units Code Sequence	(0040,08EA)	SQ		ALWAYS	AUTO
>>>>Code Value	(0008,0100)	SH	Ex.) "s"	ALWAYS	AUTO
>>>>Coding Scheme Designator	(0008,0102)	SH	Ex.) "UCUM"	ALWAYS	AUTO
>>>>Code Meaning	(0008,0104)	LO	Ex.) "s"	ALWAYS	AUTO
>>>Numeric Value	(0040,A30A)	DS	Ex.) "2.000000"	ALWAYS	AUTO
>>Relationship Type	(0040,A010)	CS	Ex.)"CONTAINS"	ALWAYS	AUTO
>>Value Type	(0040,A040)	CS	Ex.)"NUM "	ALWAYS	AUTO
>>Concept Name Code Sequence	(0040,A043)	SQ		ALWAYS	AUTO
>>>Code Value	(0008,0100)	SH	Ex.) "113737"	ALWAYS	AUTO
>>>Coding Scheme Designator	(0008,0102)	SH	Ex.) "DCM "	ALWAYS	AUTO
>>>Code Meaning	(0008,0104)	LO	Ex.) "Distance Source to Reference Point"	ALWAYS	AUTO
>>Measured Value Sequence	(0040,A300)	SQ		ALWAYS	AUTO
>>>Measurement Units Code Sequence	(0040,08EA)	SQ		ALWAYS	AUTO
>>>>Code Value	(0008,0100)	SH	Ex.) "mm"	ALWAYS	AUTO
>>>>Coding Scheme Designator	(0008,0102)	SH	Ex.) "UCUM"	ALWAYS	AUTO
>>>>Code Meaning	(0008,0104)	LO	Ex.) "mm"	ALWAYS	AUTO
>>>Numeric Value	(0040,A30A)	DS	Ex.) "480.0"	ALWAYS	CONFIG
>>Relationship Type	(0040,A010)	CS	Ex.)"CONTAINS"	ALWAYS	AUTO
>>Value Type	(0040,A040)	CS	Ex.)"NUM "	ALWAYS	AUTO

>>Concept Name Code Sequence	(0040,A043)	SQ		ALWAYS	AUTO
>>>Code Value	(0008,0100)	SH	Ex.) "123014"	ALWAYS	AUTO
>>>Coding Scheme Designator	(0008,0102)	SH	Ex.) "DCM "	ALWAYS	AUTO
>>>Code Meaning	(0008,0104)	LO	Ex.) "Target Region"	ALWAYS	AUTO
>>Measured Value Sequence	(0040,A300)	SQ		ALWAYS	AUTO
>>>Measurement Units Code Sequence	(0040,08EA)	SQ		ALWAYS	AUTO
>>>>Code Value	(0008,0100)	SH	Ex.) "T-D0010"	ALWAYS	AUTO
>>>>Coding Scheme Designator	(0008,0102)	SH	Ex.) "SRT"	ALWAYS	AUTO
>>>>Code Meaning	(0008,0104)	LO	Ex.) "Entire body"	ALWAYS	AUTO
>>Relationship Type	(0040,A010)	CS	Ex.)"CONTAINS"	ALWAYS	AUTO
>>Value Type	(0040,A040)	CS	Ex.)"NUM "	ALWAYS	AUTO
>>Concept Name Code Sequence	(0040,A043)	SQ		ALWAYS	AUTO
>>>Code Value	(0008,0100)	SH	Ex.) "111635"	ALWAYS	AUTO
>>>Coding Scheme Designator	(0008,0102)	SH	Ex.) "DCM "	ALWAYS	AUTO
>>>Code Meaning	(0008,0104)	LO	Ex.) "X-Ray Grid"	ALWAYS	AUTO
>>Measured Value Sequence	(0040,A300)	SQ		ALWAYS	AUTO
>>>Measurement Units Code Sequence	(0040,08EA)	SQ		ALWAYS	AUTO
>>>>Code Value	(0008,0100)	SH	Ex.) "111646"	ALWAYS	AUTO
>>>>Coding Scheme Designator	(0008,0102)	SH	Ex.) "DCM"	ALWAYS	AUTO
>>>>Code Meaning	(0008,0104)	LO	Ex.) "No grid"	ALWAYS	AUTO
>>Referenced SOP Sequence	(0008,1199)	SQ		ANAP	AUTO
>>>Referenced SOP Class UID	(0008,1150)	UI	Ex.) "1.2.840.10008.5.1.4.1.1.12.2"	ALWAYS	AUTO
>>>Referenced SOP Instance UID	(0008,1155)	UI	Ex.) "2.16.840.1.113669.632.3.111111.49031511150000.185.1.1.100000"	ALWAYS	AUTO
>>Relationship Type	(0040,A010)	CS	Ex.) "CONTAINS"	ANAP	AUTO
>>Value Type	(0040,A040)	CS	Ex.) "IMAGE"	ANAP	AUTO
>>Concept Name Code Sequence	(0040,A043)	SQ		ANAP	AUTO

>>>Code Value	(0008,0100)	SH	Ex.) "113795"	ALWAYS	AUTO
>>>Coding Scheme Designator	(0008,0102)	SH	Ex.) "DCM "	ALWAYS	AUTO
>>>Code Meaning	(0008,0104)	LO	Ex.) "Acquired Image"	ALWAYS	AUTO

8.1.2 Usage of Attributes from received IOD's

No SOP Class specific fields are required.

8.1.3 Attribute Mapping

The relationships between attributes received via Modality Worklist, stored in acquired images and communicated via MPPS are summarized in Table 8.1-26.

Table 8.1-26
ATTRIBUTE MAPPING BETWEEN MODALITY WORKLIST, IMAGE AND MPPS

Modality Worklist	Image IOD	MPPS IOD
--	--	Scheduled Step Attribute Sequence
Study Instance UID	Study Instance UID	>Study Instance UID
Referenced Study Sequence	Referenced Study Sequence	Referenced Study Sequence
Accession Number	Accession Number	>Accession Number
--	Request Attributes Sequence	--
Requested Procedure ID	>Requested Procedure ID	>Requested Procedure ID
Requested Procedure Description	--	Requested Procedure Description
Scheduled Procedure Step ID	>Scheduled Procedure Step ID	>Scheduled Procedure Step ID
Scheduled Procedure Step Description	>Scheduled Procedure Step Description	>Scheduled Procedure Step Description
Scheduled Protocol Code Sequence	--	Scheduled Protocol Code Sequence
Performed Protocol Code Sequence	--	Performed Protocol Code Sequence
>Scheduled Procedure Step ID	Scheduled Procedure Step ID	>Performed Procedure Step ID
--	Performed Procedure Step Description	Performed Procedure Step Description
Requested Procedure Code Sequence	Procedure Code Sequence	Procedure Code Sequence
Patient Name	Patient Name	Patient Name
Patient's ID	Patient's ID	Patient's ID
Patient's Birth Date	Patient's Birth Date	Patient's Birth Date
Patient's Sex	Patient's Sex	Patient's Sex
Referring Physician's Name	Referring Physician's Name	Referring Physician's Name
--	--	Performed series sequence
Scheduled Performing Physician's Name	Performing Physician's Name	>Performing Physician's Name
--	Operator's Name	>Operator's Name

This table shows only typical data sets.

Other data sets are also set as default settings.

All map settings, including the default setting data sets, can be customized.

8.1.4 Corrected/Modified Fields

Not applicable to this product.

8.2 DATA DICTIONARY OF PRIVATE ATTRIBUTES

Not applicable to this product.

8.3 CONTROLLED TERMINOLOGY AND TEMPLATES

Not applicable to this product.

8.4 GRAYSCALE IMAGE CONSISTENCY

This system supports the Grayscale Standard Display Function (GSDF) as described in PS 3.14, for the display monitor. When the display monitor can be calibrated according to GSDF, this system can provide the image with suitable gamma curve to the monitor.

8.5 STANDARD EXTENDED/SPECIALIZED/PRIVATE SOP CLASSES

8.5.1 Modality Worklist Information Model – Find

The Modality Worklist Information Model – Find SOP Class is extended to create a Standard Extended SOP Class by addition of standard and private attributes to the created SOP Instances as documented in Section 4.2.3.3.1.3.

8.5.2 Modality Performed Procedure Step

The Modality Performed Procedure Step SOP Class is extended to create a Standard Extended SOP Class by addition of standard and private attributes to the created SOP Instances as documented in Section 4.2.4.3.1.3.

8.6 PRIVATE TRANSFER SYNTAXES

Not applicable to this product.